

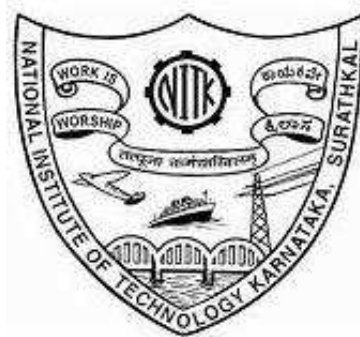
# Received Signal Strength based Localization in Wireless Sensor Networks

Thesis

Submitted in partial fulfillment of the requirements for the degree of  
DOCTOR OF PHILOSOPHY

by

**RANJAN KUMAR MAHAPATRA**



DEPARTMENT OF ELECTRONICS AND COMMUNICATION ENGINEERING  
NATIONAL INSTITUTE OF TECHNOLOGY KARNATAKA,  
SURATHKAL, MANGALORE -575025

November, 2017

# DECLARATION

I hereby *declare* that the research Thesis entitled “**Received Signal Strength based Localization in Wireless Sensor Networks**” which is being submitted to the *National Institute of Technology Karnataka, Surathkal* in partial fulfillment of the requirement for the award of the Degree of *Doctor of Philosophy* in **Department of ELECTRONICS AND COMMUNICATION** is a *bonafide report of the research work carried out by me*. The material contained in this research thesis has not been submitted to any University or Institution for the award of any degree.

RANJAN KUMAR MAHAPATRA,123018 EC12F05  
Department of ELECTRONICS AND COMMUNICATION.

Place: NITK-Surathkal.

Date:

# CERTIFICATE

This is to certify that the Research Thesis entitled “**Received Signal Strength based Localization in Wireless Sensor Networks**” submitted by **RANJAN KUMAR MAHAPATRA** (Register Number:123018 EC12F05 ) as the record of the research work carried out by him, is accepted as the *Research Thesis submission* in partial fulfillment of the requirements for the award of degree of **Doctor of Philosophy**.

Research Guide  
Dr N.S.V.SHET

Chairman-DRPC  
(Signature with Date and Seal)

## **Dedication**

This thesis is dedicated to the memory of my  
grandfather

Late Laxmi Narayan Panigrahi.

## Acknowledgements

I feel immense pleasure in expressing my profound sense of gratitude to my thesis supervisor and mentor Dr N.S.V.Shet to provide me the opportunity to work with him over the past three years. Dr N.S.V.Shet has been a wonderful advisor, providing me with support, encouragement and an endless source of ideas. His breadth of knowledge and his enthusiasm for research have always amazed and inspired me. Words won't be sufficient to quantify his immense knowledge and understanding of the subject. I thank him for the countless hours he has spent with me from research to career choices, reading my papers, and critiquing my talks. His encouraging words as well as positive reinforcement helped me to remain confident in myself and my work which motivated to keep working towards my doctorate degree during times when I felt lost. His assistance during my time at NITK has been invaluable- my life has been enriched professionally, intellectually and personally by working with Dr N.S.V.Shet.

I would also like to thank Professor M.S.Bhat, my RPAC member. Professor M.S.Bhat has been a great advisor. His enthusiasm for research and his vision for the future have been an inspiration. It was a wonderful learning experience to watch him build a successful research program in such a short time. Professor M.S.Bhat has given me support and encouragement and his advice and feedback about my research have greatly enhanced and strengthened the work. I thank him for all the time and energy he has invested for my research.

I would like to begin thanking Professor A.V.Hegde, my RPAC member whose advice, technical suggestions and discussion, helped me in my work.

I would also like to thanks to my colleagues Yajunath Kaliyath, Chandrashaker Balure, Ghoutam Simha G D, K Sareef Babu, Raghavendra M A N S for their support during my PhD.

I want to thank Mr Ratish for the help to carry out the experiments for my dissertation.

Ranjan Kumar Mahapatra

# Abstract

**Context:** The localization of the sensor nodes has become a critical issue in the context of wireless sensor networks (WSNs). A convenient way to estimate the location of the static objects is to exploit received signal strength (RSS) attenuation with the distance, as it does not require any extra hardware. This has become feasible as received signal strength indicator (RSSI) is a common and standard feature in almost all the sensor nodes radios. RSSI can be recorded automatically by the received messages. On the contrary received signal strength is variable, noisy, unstable and challenging to use in practice.

This doctoral dissertation investigates the feasibility of sensor nodes for distance estimation as well as for localization, with the available resources for wireless sensor network. This work makes use of the RSS efficiently. Further it provides experimental support to the hypothesis that appropriate modeling of received signal strength behavior and propagation modeling parameters are prerequisite to the applicability of wireless sensor network in real-time applications. This dissertation is associated with: (1) the selection criteria for the sensor nodes to be chosen for distance estimation as well as for localization, (ii) identifying the several factors that influence the variability of the received signal strength, (iii) modeling of the RF propagation in wireless sensor networks, (iv) defining the basic sensor network deployment constraints which can ensure efficient distance estimation as well as localization.

IRIS motes from MEMSIC were deployed in real-time indoor environments to assess the practical values of the received signal strength, RF models. In this work, RSS variability, various environmental conditions were investigated. Several factors that influences signal propagation which causes RSS variation and the existing constraints from wireless sensor network were reckoned to design suitable model for indoor localization.

The distance estimation and localization contemplation, by means of factors influencing RSS, distance estimation, localization were combined to validate the implication in real-time indoor environments, which concerns performance of the distance estimation as well as localization.

# Contents

Acknowledgements . . . . .	i
Abstract . . . . .	ii
List of figures . . . . .	v
List of tables . . . . .	viii
Nomenclature . . . . .	ix
Abbreviations . . . . .	ix
<b>1 Introduction</b>	<b>1</b>
1.1 Problem Overview . . . . .	2
1.2 Main Objectives . . . . .	3
1.3 Contributions . . . . .	4
1.4 Organization of the doctoral dissertation . . . . .	5
<b>2 Background and related Research</b>	<b>7</b>
2.1 Introduction . . . . .	8
2.2 Wireless Sensor Networks . . . . .	8
2.2.1 Definition: . . . . .	8
2.3 Applications: . . . . .	9
2.3.1 Motivating Application: . . . . .	10
2.3.2 WSN Constraints: . . . . .	11
2.4 A WSN Model: . . . . .	11
2.5 Sensor Network Topology . . . . .	12
2.6 Sensor node architecture . . . . .	14
2.7 RF propagation Technique . . . . .	18
2.7.1 Free space propagation . . . . .	19
2.7.2 Reflection: . . . . .	20
2.7.3 Diffraction: . . . . .	21

2.7.4	Scattering: . . . . .	21
2.7.5	Free-space model: . . . . .	21
2.7.6	Log-normal path loss model: . . . . .	22
2.7.7	Related research: . . . . .	23
2.7.7.1	Localization Techniques . . . . .	23
2.7.7.2	Range-based Localization Scheme . . . . .	25
2.7.7.3	Time of Arrival(ToA): . . . . .	25
2.7.7.4	Time Difference of Arrival(TDoA) . . . . .	26
2.7.7.5	Angle of Arrival measurement(AoA): . . . . .	27
2.7.7.6	Received Signal Strength (RSS) : . . . . .	28
2.7.7.7	Comparison of Localization methods: . . . . .	30
2.7.8	RSS Issue: . . . . .	35
2.7.8.1	Path Loss: . . . . .	36
2.7.8.2	Fading: . . . . .	37
2.7.9	RSS limitation and challenges . . . . .	38
2.7.10	Problem overview . . . . .	39
<b>3</b>	<b>Experiments on factors influencing the RSS.</b>	<b>41</b>
3.1	Introduction . . . . .	42
3.2	Sources of RSS variability . . . . .	42
3.2.1	Factors related to sensor hardware: . . . . .	43
3.2.2	Factors related to the environment . . . . .	43
3.2.2.1	Radio Frequency: . . . . .	44
3.2.2.2	Transmitter Power level . . . . .	49
3.2.2.3	Fluctuation due to different sensors . . . . .	51
3.2.2.4	Results . . . . .	52
3.2.2.5	Height of the transceiver . . . . .	52
3.2.3	Basic setup for the experiment. . . . .	52
3.2.3.1	Variation in RSSI at different height above ground . . . . .	56
3.2.3.2	Variation due to the Receiver movement (fixed $T_x$ ): . . . . .	62
3.2.3.3	Results: . . . . .	63
3.2.3.4	Conclusion: . . . . .	64
<b>4</b>	<b>RF signal propagation and RSSI model.</b>	<b>66</b>
4.1	Introduction . . . . .	67



4.1.1	Testbed: . . . . .	67
4.1.2	RSSI model: . . . . .	69
4.1.2.1	Calculation of Path Loss Exponent (PLE) : . . . . .	71
4.1.2.2	Results and analysis: . . . . .	72
<b>5</b>	<b>RSS measurement and mitigation of abnormal RSS values.</b>	<b>75</b>
5.1	Experiments and results . . . . .	76
5.1.1	Experimental setup . . . . .	76
5.1.1.1	Basic Assumptions for the experiment. . . . .	76
5.1.1.2	Software and Hardware setup . . . . .	76
5.1.1.3	Results and analysis: . . . . .	78
<b>6</b>	<b>RSS based Localization.</b>	<b>84</b>
6.1	Introduction . . . . .	85
6.2	Experimental setup: . . . . .	85
6.2.1	Flow Chart for Localization: . . . . .	88
6.2.2	Algorithm for Localization: . . . . .	88
6.3	Localization Application: . . . . .	93
6.3.1	Need for Localization: . . . . .	93
6.3.2	Need for accuracy: . . . . .	94
<b>7</b>	<b>Conclusion and Future directions.</b>	<b>95</b>
	<b>Publications based on the thesis</b>	<b>106</b>

# List of Figures

2.1	Wireless sensor network . . . . .	9
2.2	WSN Model . . . . .	12
2.3	Wireless sensor network topologies . . . . .	13
2.4	Wireless sensor network topology . . . . .	14
2.5	Wireless sensor node architecture . . . . .	15
2.6	Types of sensor node . . . . .	17
2.7	Electromagnetic Wave . . . . .	18
2.8	Two ray model . . . . .	20
2.9	Free space path loss model for $n=4.06$ . . . . .	22
2.10	Log-normal path loss model for different values of $n$ . . . . .	23
2.11	Physical Measurement . . . . .	23
2.12	Classification . . . . .	24
2.13	Circle of uncertainty . . . . .	25
2.14	TDoA . . . . .	26
2.15	TDoA measurement defining Hyperbola . . . . .	27
2.16	Angle of Arrival . . . . .	28
2.17	Path loss, Shadowing and multipath . . . . .	36
2.18	Doppler effect . . . . .	37
2.19	Classification of Small-scale fading . . . . .	38
3.1	Sensor Network deployment . . . . .	44
3.2	RSSI measurement at Node ID 100 with various channel . . . . .	45
3.3	RSSI measurement at Node ID 200 with various channels . . . . .	46
3.4	RSSI measurement at Node ID 300 with various channels . . . . .	46
3.5	RSSI measurement at channel 14 with various nodes . . . . .	47
3.6	RSSI measurement at channel 17 with various nodes . . . . .	47
3.7	RSSI measurement at channel 20 with various nodes . . . . .	48

3.8	RSSI measurement at channel 23 with various nodes . . . . .	48
3.9	RSSI measurement at channel 26 with various nodes . . . . .	49
3.10	Fluctuation in RSSI due to different power level . . . . .	50
3.11	Fluctuation in RSSI due to same power level at different nodes . . . . .	50
3.12	RSSI fluctuation due to different power level in different sensor nodes . . . . .	51
3.13	RSSI fluctuation at 0.10m to 1.33m . . . . .	54
3.14	RSSI fluctuation at height 0.10m . . . . .	54
3.15	RSSI fluctuation at height 0.241m . . . . .	54
3.16	RSSI fluctuation at height 0.338m . . . . .	55
3.17	RSSI fluctuation at height 0.5334m to 1.33m using tripod . . . . .	55
3.18	Measured RSS values (different heights vs no of samples recorded) . . . . .	56
3.19	RSSI fluctuation at different time interval (0.10m above ground) . . . . .	57
3.20	RSSI vs Distance characteristics at 1m with 0.10m above ground) . . . . .	57
3.21	RSSI fluctuation at different time interval (0.241m above ground) . . . . .	58
3.22	RSSI vs Distance characteristics at 1m with 0.241m above ground) . . . . .	59
3.23	RSSI fluctuation at different time interval (0.338m above ground) . . . . .	60
3.24	RSSI vs Distance characteristics at 1m with 0.338m above ground) . . . . .	60
3.25	RSSI fluctuation at different time interval (0.533m above ground) . . . . .	61
3.26	RSSI vs Distance characteristics at 1m with 0.533m above ground) . . . . .	62
3.27	Comparison . . . . .	62
3.28	Mobility of the receiver with fixed sensor node at different distances . . . . .	63
3.29	Maximum RSSI with mobile receiver . . . . .	63
3.30	RSSI-Distance relationship among static and mobile receiver . . . . .	64
4.1	Sensor node and Base Station for experiment . . . . .	68
4.2	Placement of sensor node . . . . .	68
4.3	Register containing RSSI value . . . . .	69
4.4	Work Flow . . . . .	70
4.5	Distance-RSSI . . . . .	74
5.1	Wireless Sensor Network Setup . . . . .	77
5.2	Sensor Nodes installed on Tripods in Research Lab . . . . .	77
5.3	Experimental Model (BS and Nodes in LOS) (Top-View) . . . . .	78
5.4	Fluctuation of RSS at distance from 1m to 3.25m . . . . .	81
5.5	Fluctuation of RSS at distance from 3.5m to 6m . . . . .	81

5.6	Distance vs Mean RSSI . . . . .	82
6.1	Procedure of Localization . . . . .	85
6.2	Flow chart to select the sensors for localization . . . . .	86
6.3	architecture for Distance estimation experiment . . . . .	87
6.4	Real time placement of sensors for Location Estimation . . . . .	87
6.5	Sensor placement for localization experiment . . . . .	88
6.6	Flow chart for localization . . . . .	89

# List of Tables

2.1	Comparative analysis of different Localization methods (2000-2007) . . .	31
2.2	Comparative analysis of different Localization methods (2008-2010) . . .	32
2.3	Comparative analysis of different Localization methods (2012-2013) . . .	33
2.4	Comparative analysis of different Localization methods (2014-2017) . . .	34
2.5	Comparison of methods . . . . .	35
3.1	Maximum and minimum value of mean RSSI for different nodes . . . .	49
3.2	Maximum and minimum value of mean RSSI for this experiment . . .	51
3.3	Base Station and sensor nodes parameters . . . . .	53
3.4	Fluctuated RSSI Values at height 0.10m . . . . .	56
3.5	Fluctuated RSSI Values at height 0.241m . . . . .	58
3.6	Fluctuated RSSI Values at height 0.338m . . . . .	59
3.7	Fluctuated RSSI Values at height 0.533m . . . . .	61
4.1	Measured data of the conducted experiment . . . . .	71
5.1	Fluctuated RSSI Values at 1m to 3.25m . . . . .	79
5.2	Fluctuated RSSI Values at 3.5m to 6m . . . . .	80

## Abbreviations

Abbreviation	Expansion
ADC	Analog-to-Digital Converter
AMR	Anisotropic Magneto Resistive
AoA	Angle of Arrival
BS	Base Station
CH	Cluster Head
non-CH	Non Cluster Head
LEACH	Low Energy Adaptive Clustering Hierarchy
GPS	Global Positioning System
MEMS	Micro Electro Mechanical System
MSE	Mean Square Error
MMSE	Minimum Mean Square Error
LoS	Line of Sight
NLoS	Non Line of Sight
PLE	Path Loss Exponent
QoS	Quality of Service
RSSI	Received Signal Strength Indicator
RFID	Radio-frequency Identification
Tx	Transmitter
Rx	Receiver
RF	Radio Frequency
ToA	Time of Arrival
TDoA	Time Difference of Arrival
TDMA	Time Division Multiple Access
WSN	Wireless Sensor Network

# Chapter 1

## Introduction

Chapter 1 presents an introduction to the major problems accompanied in the use of received signal strength (RSS) in the distance estimation and localization applications. Subsequently scope of the study, aims and objectives, research questions, research methods are presented. Organization of the thesis and main thesis goals are outlined. Later contributions are formulated.

## 1.1 Problem Overview

Wireless sensor network as compared to other wireless networks, comprises of large number (hundreds to thousands) of low cost and small sized (comparable to coin) sensor nodes. As sensor nodes are battery driven, there is always a limitation of consumption of energy, which is the cause for requirement of small sensor modules.

The localization of the wireless sensor nodes has become an crucial issue in wireless sensor network applications. An appealing way to estimate the location of unknown sensor nodes, is to use received signal strength attenuation with distance. It does not require any extra hardware as almost all the sensor nodes possess a standard feature of received signal strength indicator (RSSI) which is recorded from the received messages.

As the primary focus on this work is on wireless sensor networks operating in indoor environment, GPS cannot be used. Hence, RSS based technique in localization is a good alternative. But, RSS is noisy, varies with several environmental factors, unstable and challenging to use in practice. Hence, intensive study is essential to understand the nature of RSS behavior and its dependencies. In reference to these, some problems with higher priority are:

- Selection of sensors from a group of sensors which have almost similar characteristic for RSS is essential for distance estimation as well as for localization.
- Detailed investigation of RSS behavior at several distances in dynamic indoor environment is not done. Hence for distance estimation and localization, thorough analysis of the RSS behavior in various environmental conditions is required.
- In general, log normal path loss model for received signal strength based localization, excludes the influence of several factors such as  $T_x$  power level, radio channels etc., on RSS. Hence there is a need for specific model for wireless sensor network.
- Various published research work on RSS based localization is simulation based rather than real-time experimented work. Simulation based work considers the RSS uncertainty as statistical quantity instead of detailed investigation. Hence there is a need for detailed experimental study.

Hence, investigating the above problems is of primary task to use the RSS efficiently for distance estimation as well as for localization.



## 1.2 Main Objectives

This doctoral dissertation investigates the feasibility of wireless sensor node distance estimation as well as localization with the available resources with the help of received signal strength only. The main research objectives are formulated as follows.

1. To propose a sensor selection method based on RSSI variation:

Analysis of RSS behavior in several conditions, such as distance within the range of 0 to 10m; variation in height from the ground to the acceptable height of tripod; different indoor environments, i.e., experimental area with LoS and NLoS, variation in all frequency bands within 2.4 GHz, different sensor nodes under the common conditions to investigate the effect of sensor hardware tolerance factors as well as variation in different transmission powers, were carried out with series of experiments.

2. To develop a RSSI based distance estimation technique using Gaussian filtering.

Signal strength from each sensor node has been measured for distance estimation. Due to temperature, reflection, diffraction, multipath, obstacles etc, the signal propagated is random in nature. These conditions affect RSSI mostly in turn it affects distance estimation and increases the inaccuracy. Due to the presence of unavoidable conditions as discussed above in the indoor environment, abnormal changes in the RSSI values can be noticed. Hence to achieve better accuracy in distance estimation, mitigation of abnormal changes in RSSI value is necessary. For this work, gaussian filtering method has been used to mitigate the abnormal RSSI.

3. To create a testbed and analyze the effectiveness of the proposed RSSI based method.

To model the factors that influences the RSSI in free-space path loss and to study the effectiveness of the mitigation method imposed in real time, RSSI modeling has been carried out. Also testbeds with sensors were created in different indoor conditions.

4. To propose a localization method to localize an unknown sensor node.

Sensor localization in indoor environment with different conditions have been investigated and a method has been proposed to localize the unknown sensor node. To achieve this, real-time experiments were carried out.

## 1.3 Contributions

In this doctoral dissertation, main contributions are presented as follows:

- Analysis of several influencing factors such as variation in frequency of operation of sensor radio, distance between transmitter and receiver, sensor hardware tolerance, height of the transmitter as well as receiver from the ground, transmitter power, mobility of the receiver on received signal strength was carried out. A series of experiments using IRIS motes were carried out in real-field indoor environment to analyze the factors which impacts RSSI. Based upon the obtained results, selection of sensors was carried out for further experiments.
- Experimental analysis of small wireless sensors for distance estimation was carried out with the help of RSSI modeling. Path loss exponent and variance was measured based on the real-time experiments in different indoor conditions.
- Implementing RSS based algorithm to define the conducted experiments as the resources of data, preparing conditions for analysis on path loss exponent, distance measurement, gaussian filtering and finally localization of the sensor.
- Due to the different indoor conditions, RSSI values have been fluctuating either to higher a value or lower value, which was not normal. Hence mitigation of those abnormal RSSI values was essential to proceed further. With the help of Gaussian filtering and averaging filter at different distances, mitigation of abnormal values was quite successful.
- To have the proper position of the unknown sensor node, a localization method was proposed. Sensors were placed in real-time indoor conditions and based upon the received signal strength, experiments to localize the unknown sensor node was carried out.

## 1.4 Organization of the doctoral dissertation

This doctoral dissertation is organized in seven chapters. The first one is the introductory chapter which describes the problems associated with the use of received signal strength. Second chapter depicts the overview of background and related research work. Third chapter describes the experiments carried out in real-time indoor environment. Fourth chapter describes how the modeling of the RSS is done for signal propagation. Collection of RSS values are recorded and how the received abnormal RSS values are mitigated is explained in fifth chapter. Sixth chapter offers the experimental work to localize an unknown sensor node. Finally with brief summary, dissertation is concluded with future directions narrated in seventh chapter. A synoptic description of the content of the individual chapters are as follows:

Based on the proposed work, the contents of the thesis is organized as follows,

1. Chapter-1: Introduction.

Chapter 1 provides a concise overview of the main problems related to RSS variation. Main objectives, contributions are also formulated in this chapter.

2. Chapter-2: Background and related Research.

It explains the basic background, that is necessary to understand the analysis and experimental work in this dissertation. A concise introduction to the wireless sensor network technology, widely used most common methods for localization, propagating models and aspects related to the placement of the sensor nodes is offered. Apart from this, drawbacks related to the discussed methods were identified to carry out further investigation.

3. Chapter-3: Experiments on factors influencing the RSS.

The vital factors that influences the RSS are identified and investigated by series of real-time indoor experiments in different conditions. The relation that exists between received signal strength and distance is investigated by series of experiments.

4. Chapter-4: RF signal propagation and RSSI model.

Chapter 4 explains the propagation of radio waves and as well as the modeling of RF techniques which includes the path loss factor that affects the received signal strength. Moreover practical radio models which considered the factors,

that affect RSS, suitable for wireless sensor network are also explained. The methods are validated by experimenting with IRIS mote within the range of 2.4 GHz frequency bands by processing CC2420 radio chip. At last classification of sensor network environment is also presented.

5. Chapter-5: RSS measurement and mitigation of abnormal RSS values.

The details of the RSS received from the experiments carried out. These results also includes the abnormal RSS values. So method to mitigate the abnormal values is also presented by introducing gaussian and averaging filter.

6. Chapter-6: RSS based Localization.

It investigates the feasibility of the wireless sensor node localization with the available resources by using only received signal strength. This chapter depicts in detailed study of the localization of unknown sensor nodes. A method based on sensor selection is proposed for localization of unknown sensor node.

7. Chapter-7: Conclusion and Future directions.

Finally Chapter 7 concludes with summary of the research carried out with concise conclusion and future ideas.

# Chapter 2

## Background and related Research

Chapter 2 offers the basic study that is essential to understand the annotation and the experiments carried out in this doctoral thesis. A concise introduction to the wireless sensor networks technology, models related to RF signal propagation, distance estimation methods, localization methods as well as the attributes related to sensor deployment, are explained. Furthermore shortcomings related to those methods are identified to investigate further.

## 2.1 Introduction

Chapter 2 depicts the brief introduction to the major topics discussed in this dissertation and offers essential information required to understand the exposition in the successive chapters.

The primary concepts related to wireless sensor networks (WSNs) architecture, topology, working features of the sensor node hardware are concisely reviewed. Several factors which influence radio frequency (RF) propagation in indoor environment in different conditions have been introduced. The explanation related to signal propagation and different phenomena, which are provided in the subsequent chapters in real-time indoor environment plays a vital role in steady operation of wireless sensor network. The appropriate perception of the radio signal propagation methods in several condition with wireless sensor network specifics, aid to the genesis of realistic models, helps in localizing the sensor node effectively. Some of the related examples critical comments towards there limited applicability are made.

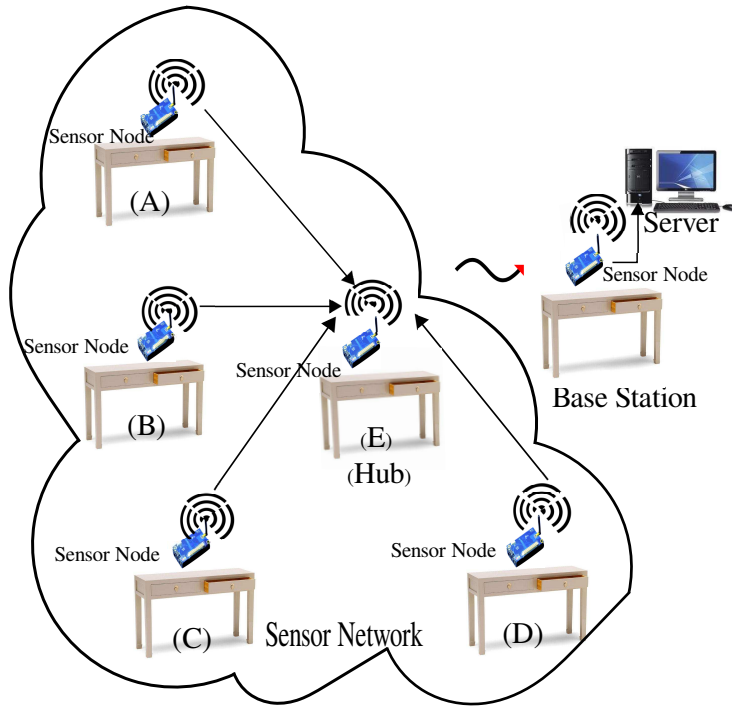
## 2.2 Wireless Sensor Networks

Wireless sensor network is one of the emerging technology for real world,s where applications are automated and require minimal human intervention (Sahu and Dubey, 2009), (Sahu and Dubey, 2009) . Recent days the focus is on real-world indoor applications such as patient monitoring, fire alarm, intrusion detection etc.

### 2.2.1 Definition:

In [Dargie and Poellabauer (2010)] and [Akyildiz *et al.* (2002)], WSN is defined as, wireless sensor network in general comprises of a large number of sensor nodes co-operating with each other in indoor environment, which are tiny in size and battery operated. Pre-determined position of the sensor node is not necessary in all the practical scenarios which facilitates the random placement of the sensor node for harsh situations in the terrains which are not accessible. The Figure. 2.1 represents a general example of wireless sensor network.

Here in this particular indoor network as shown in Figure. 2.1, sensor nodes A, B, C, D communicates with sensor node E and sensor node E aggregates the information



**Figure 2.1:** Wireless sensor network

as well as communicates to the base station.

Sensor nodes are also designed to work in several harsh indoor environments such as fire alarm, intrusion detection etc., in different conditions. This illustrates the working integrity of the sensor network in different topologies. Here each of the sensor node senses the required physical event, collects the required data, communicates to the nearest hub. Then the data get processed and transferred from the hub to the base station as shown in the above Figure.

## 2.3 Applications:

Deployment of large number of sensors (typically 10-1000 or more) to observe the physical phenomena like indoor fire fighting, intrusion detection, vehicle detection, as well as monitoring of other target objects, are mostly random in nature. Some of these applications are listed in [Akyildiz *et al.* (2002)] and [Dargie and Poellabauer (2010)] as:

- indoor applications (domestic automation, home surveillance, smart-home etc.)

- health application (Patient location as well as behavior monitoring, organ functioning etc.)
- civil as well as commercial applications (air traffic control , traffic monitoring (Knaian, 2000), warehoused materials detection etc.)
- moving vehicle detection using AMR magnetic sensors (Caruso and Withanawasam, 1999).
- structural health monitoring (Koh and Dyke, 2007).
- single as well as multiple damage detection using natural frequencies (Dargie and Poellabauer, 2010).

### 2.3.1 Motivating Application:

#### ***Logistics:***

Deployment of sensors in office environment, hospitals, warehouse, factories etc., plays an important role for unassisted monitoring (Patwari *et al.*, 2003) and (Patwari *et al.*, 2005). Earlier the deployment was wired, but now a days sensors are wireless devices, which eventually reduces the cost of cables and manpower. A typical indoor application include Logistics where boxes, different parts, office equipments are warehoused. When these are brought into the facility equipped with sensors, storage conditions such as temperature, humidity etc., are monitored and heating, ventilation as well air conditioning can be controlled. Location of equipments can be monitored if it is stationary or can be tracked if it is to be moved out from the office or warehouse. If the equipment is lost somewhere or it needs to be found out during auditing, sensor equipped materials report their location to the server.

Now RFID tags are kept on the cartons, boxes, office equipments which are entering into the warehouses (Kumagai and Cherry, 2004). Location of objects with RFID can be identified only when they are few feet nearby the reader. Hence all other objects remain out of access area in warehouse all the time. But sensors which are networked, can be located if they are within the specified range.



### 2.3.2 WSN Constraints:

Number of sensors to be used for the application as well as how much energy will be consumed depends upon the sensor network topology as well as on architecture. Wireless sensor network approach generally involves:

- Collection of relevant data from the physical event (application oriented).
- Estimation of distance or angle.
- Based upon the above information, by the help of algorithm, localization is achieved.

Some of the Constraints which impacts on wireless sensor network can be summarized as:

- Energy management [Dalce *et al.* (2012)].
  - Data redundancy impacts energy consumption.
  - Data aggregation helps for the purpose [Awang and Agarwal (2013)].
  - Reduction of idle listening in the network (as energy consumption in listening time > energy consumption in emitting time).
  - Computation approach (either centralized or distributed).
- Access to the anchor nodes.

## 2.4 A WSN Model:

Figure. 2.2 represents a standard model of wireless sensor network. Here events from several sensors (to and from) pass through two different channels (i.e. sensor channel and wireless channel). Whenever any event occurs, sensor senses the phenomena via sensor channel and conveys the information in terms of packets to the end user via wireless channel.

Here both the channels help in sensing the physical event as well as transmitting the information simultaneously.

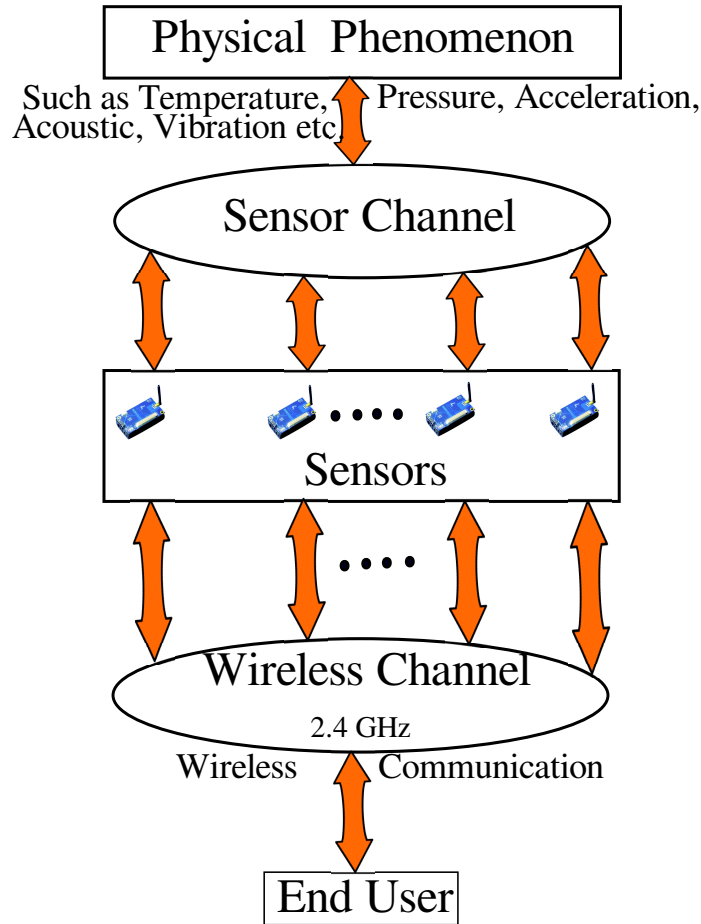
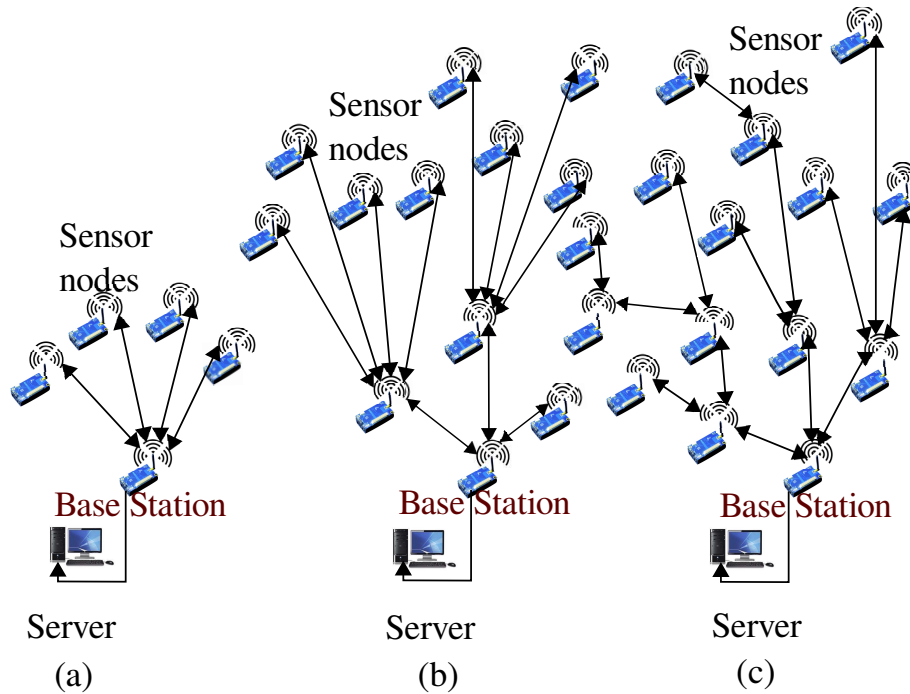


Figure 2.2: WSN Model

## 2.5 Sensor Network Topology

In some sensor network applications, several thousand numbers of sensors are deployed. By definition in [Santi (2005)], with the reduction of the energy and/or by increasing the capacity of the network, desired connectivity is produced based upon the transmitting ranges of the coordinating nodes decisions. It also depicts how hardware components are configured for data transmission within that configuration. Some of the basic network topologies has been shown in 2.3:.

- Direct communication Figure. 2.3(a).
- Cluster formation. Figure. 2.3(b).
- Multi-hop communication. Figure. 2.3(c).



**Figure 2.3:** Wireless sensor network topologies

The Moteview software used in this work has the following features :

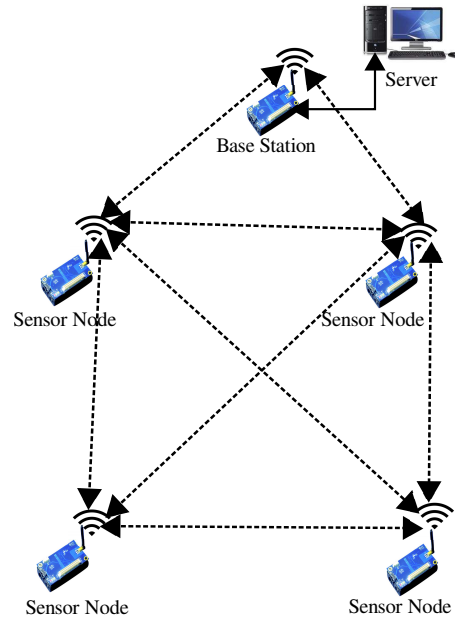
- Multi-hop.
- Mesh network.

One of the typical topology used by this software is shown in the Figure. 2.4.

This network comprises of sensor nodes, in which communication between the nodes follow wireless medium. Messages are routed to base station and then to the destined server or to the remote client. Radio communication between sensor node and base station/ server is enhanced with multi-hop. Here XMesh is used to re-route messages that helps to overcome the difficulties of communication due to the presence of obstacles. Battery life of the sensors are enhanced by keeping all the sensors in the sleep state until and unless required to wake up for any communication activities.

The software that runs using TinyOS on sensor nodes is XMesh. Sensor nodes used for the experiments comprise of:

- A Micro-controller:  
IRIS mote uses Atmel Atmega1281 micro-controller with :



**Figure 2.4:** Wireless sensor network topology

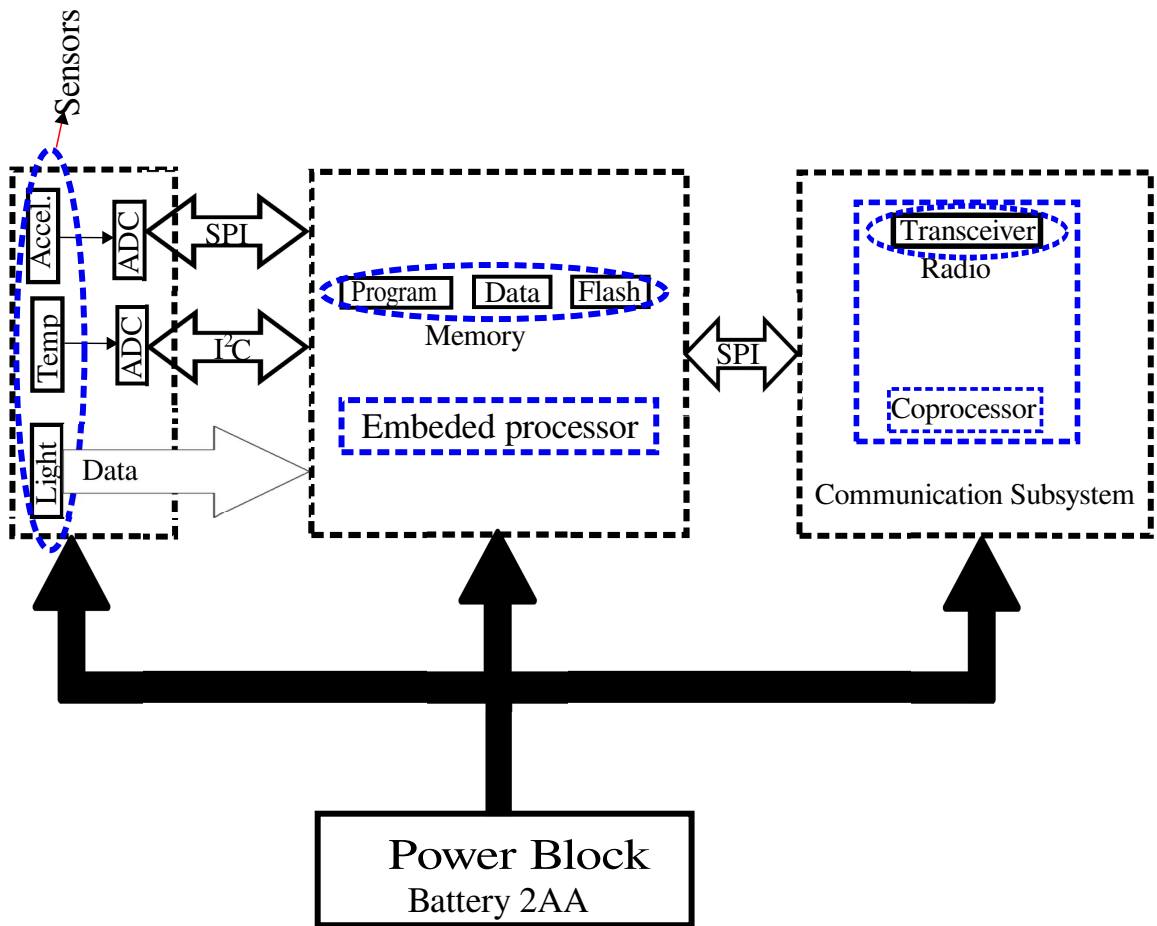
- flash memory (128K).
- RAM (8K).
- EEPROM (4K).
- A radio:  
It uses Atmel RF230, IEEE 802.15.4 compliant radio.
- A serial flash:  
Over the air programming is support by 128k flash memory

## 2.6 Sensor node architecture

Advancement in sensor device design takes care of the :

- Small size (comparable to coin).
- High speed processor.
- Addition of features to capture different environmental activities.
- Less power consumption.

A typical sensor node architecture [Dargie and Poellabauer (2010)] is shown in Figure. 2.5.



**Figure 2.5:** Wireless sensor node architecture

Collection of data from the physical events, processing the received data and to transfer the data to the destination, are the basic ability of the sensor now a days. These features pre-determines the internal architecture of the sensor nodes. Sensor node consists of several modules such as sensing (physical events), ADCs, data processing, radio as well as power.

A concise summary describing the purpose as well as the functions of the different modules (named as blocks) are given below:

- Sensing block.

Sensing block integrates one or more physical sensors (such as temperature, light, acceleration etc.,) with corresponding ADCs with the help of multiplexing

schemes for sharing. Virtual world is interfaced with the physical world with the help of sensors. ADC interfaces the sensing entity with digital processor block as output of the transducer is analog with continuous magnitude as a function of time.

- Memory.

Memory block is directly dependent upon the data acquisition rate and it varies from sensors to sensors ( temperature sensor uses sampling frequency less than 1 Hz i.e.one byte of data per second but high resolution camera can produce 10's of Mbits of data per second).

- Processor block.

The processor block may be a normal processor, microprocessor or a micro-controller. The sensors (XM2110) used for the experiments carried out are integrated with Atmega1281 low power micro-controller. It runs from its internal program flash memory (128K bytes) with measurement flash memory (512K bytes).

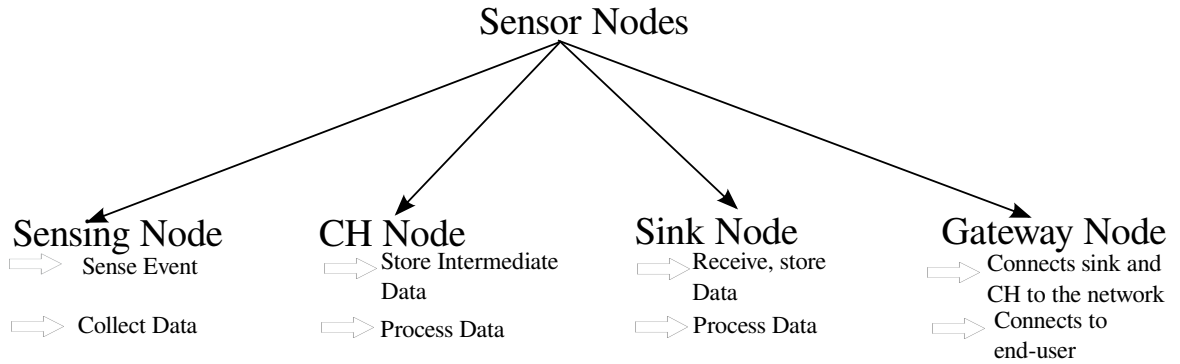
- Radio block.

Radio block uses IEEE 802.15.4 compliant RF transceiver. It is used in low power as well as low voltage applications. This transceiver connects the sensor node to the network either by local coordination or sensor-BS coordination (multi-hop). This radio is tuned within IEEE 802.15.4 channels from 11 (2.405 GHz) to 26 (2.480 GHz) in 5 MHz steps.

- Power block:

To power up the sensors, it can be connected to either main power of industrial machine or with battery. Sensor nodes used in this work are battery powered. It matches up with two AA batteries. Here output of the battery power should be within 2.7 VDC to 3.6 VDC.

According to the functional activities (as per the application requirement), sensor nodes can be categorized as shown in the Figure .2.6. Sensing node senses the physical



**Figure 2.6:** Types of sensor node

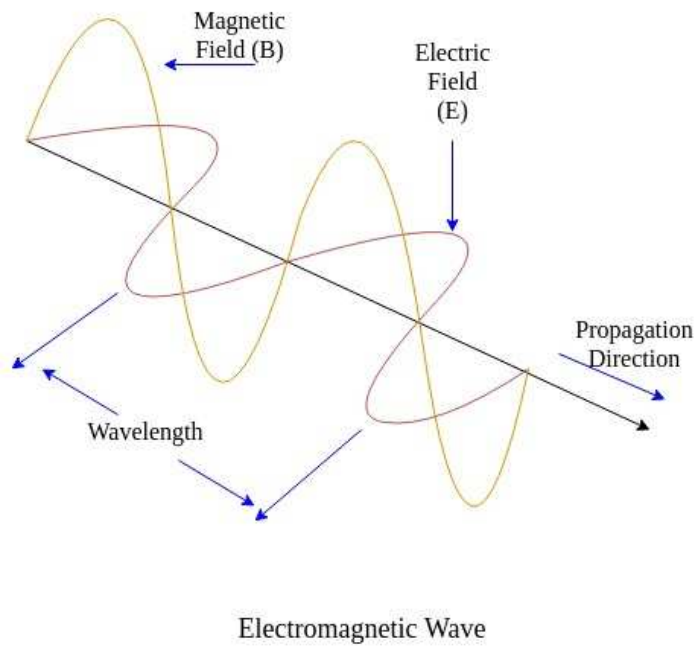
event and collect the data as per the application requirement. CH node stores the intermediate data, processes it if required and transmits it. All the intermediate processed data is collected by the sink node. It stores the data and processes it as per the requirement. Finally the gateway node connects the sink as well as CH node to the network. It also directly communicates with the end-user.

As sensors with different sensing elements are available in the market, we can also categorize the wireless sensor network to be:

- **Homogeneous:** If all the sensors used for the experiments contains same hardware elements, the network formed is named as homogeneous network otherwise it is termed as heterogeneous.
- **Hierarchical:** If the sensor nodes are grouped together for a specific purpose/ event in different integrated layers, then this type of wireless sensor network is named as hierarchical network, otherwise termed as flat network.
- **Static:** When the deployed sensor nodes are stationary, network is named as static otherwise it is termed as mobile.
- **Reactive:** When the deployed sensor nodes sense the data according to the changes in the surrounding environment, then it is named as reactive otherwise it is termed as programmed if the wireless sensor network performs a specific task as per the application requirement.

## 2.7 RF propagation Technique

Radio waves propagate through the free space in the form of electromagnetic radiation [Blake (2000)] which creates electric as well as magnetic field either in free space or in some of the physical medium. In free space, radio waves propagate as transverse electromagnetic (TEM) waves where electric field, magnetic field and the direction of propagation of radio waves are mutually perpendicular to each other (Figure 2.7).



**Figure 2.7:** Electromagnetic Wave

In general, when electrons move through a conductor or set of conductors (i.e. antenna), radio wave is said to be generated. The moment it is launched, radio waves in the form of electromagnetic waves travel either through free space or in any acceptable medium. Good dielectrics allow radio waves to pass through. Radio waves propagate at the speed of light in free space where as velocity becomes lower in other media. The velocity of propagation is given as:

$$v_p = \frac{c}{\sqrt{\epsilon_r}} \quad (2.1)$$



where  $v_p$  = velocity of propagation in the medium  
 $c = 3 \times 10^8 \frac{m}{s}$ , velocity of propagation in free space.  
 $\epsilon_r$  = Relative permittivity of the medium.

When radio wave passes through the medium or from one medium to the other, it suffers from reflection, diffraction, scattering. Received power as well as path loss are the most important parameters as predicted by the most of the propagation models. The following subsections describes the brief overview of the basic wave propagation mechanism.

### 2.7.1 Free space propagation

A point in the space can be considered as the source of electromagnetic wave where radiation would be equal in all directions which is termed as an isotropic radiator (Blake, 2000), (Rappaport et al., 1996). Though existence of a point source is not possible but approximation at a large distance as compared to the source dimension is good enough.

Free space is considered when a clear and unobstructed LoS path exists between transmitter and receiver. Here it is assumed that there is no loss of energy as the wave propagates through free space but attenuation occurs due to spreading of the waves. As we are talking of an isotropic radiator, radiation is equal in all direction. Hence power density  $P_D$  is represented as :

$$P_D = \frac{P_t G_t}{4\pi r^2} \quad (2.2)$$

Where  $P_D$  is the power density in  $W/m^2$

$P_t$  is the power transmitted in W

$G_t$  is the gain of the transmitting antenna.

$r$  is the distance from the antenna in m.

The attenuation we observe here is due to the spreading of the energy as we move farther from the source.

The effective area of an antenna can be termed as :

$$A_{eff} = \frac{P_R}{P_D} = \frac{G_R \lambda^2}{4\pi} \quad (2.3)$$

where  $P_R$  is the power received in  $W$ .  $G_R$  is the gain of the receiving antenna and  $\lambda$  is

the operating wavelength. Now by combining equation (2.2) and equation (2.3), Friis equation for received power is given as :

$$P_R = \frac{P_t G_t G_R \lambda^2}{4\pi r^2} \quad (2.4)$$

Equation 2.4 is written in decibel as:

$$P_R(d) = P_t + G_t + G_R - (32.44 + 20\log d + 20\log f) = P_t + G_t + G_R - L_{fs} \quad (2.5)$$

where  $d$  is the distance between  $T_x$  and  $R_x$

and  $f$  is the frequency of operation and  $L_{fs}$  is the free space path loss in decibel.

Details of the transformation of the Equation 2.5 is given in Appendix ??

### 2.7.2 Reflection:

Reflection is one of the most important factor that is associated with the variation of RSS. It occurs when RF wave hits on an object with very large dimension (such as surface of earth, buildings, walls etc.) as compared to the propagating wavelength (Rappaport et al., 1996). The propagating RF wave gets reflected and refracted (par-

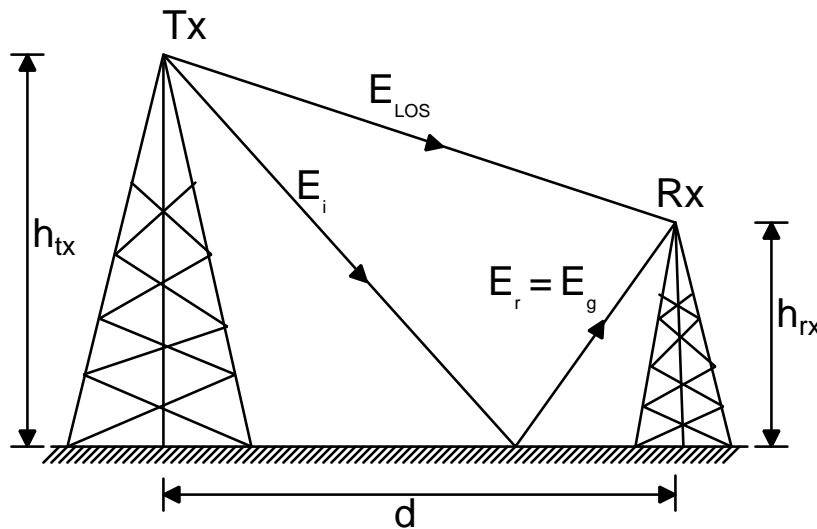


Figure 2.8: Two ray model

tial), when it propagates from one medium to the other with different electrical properties. When RF wave incidents on the perfect dielectric, one portion of the wave

is reflected back in the 1<sup>st</sup> medium and rest is refracted to the 2<sup>nd</sup> medium. If the second medium is a perfect conductor, then all the energy is reflected back to the first medium without any loss of energy.

According to the two ray propagation model as shown in Figure .2.8 [Rappaport et al. (1996)], two paths of propagated wave which arrive at receiver is of different phase. At receiver, they add up either constructively or destructively which in turn impact the RSS.

### **2.7.3 Diffraction:**

Diffraction occurs when a portion of the propagating wavefront is partially blocked, by any object with round or sharp edges. Huygen's principle explains that all the points on the wavefronts are point sources which further produces the secondary wavelets and these secondary wavelets travel to a shadowing region which causes the diffraction. Here vector sum of all the electrical components of the secondary wavelets provides the field strength of the propagated wave. Fresnel knife-edge diffraction model is used to model the diffraction (Rappaport et al., 1996). But there is a limitation to this model like it raises to inaccuracies as the model does not consider some factors like polarization, conductivity etc (Goldsmith, 2005).

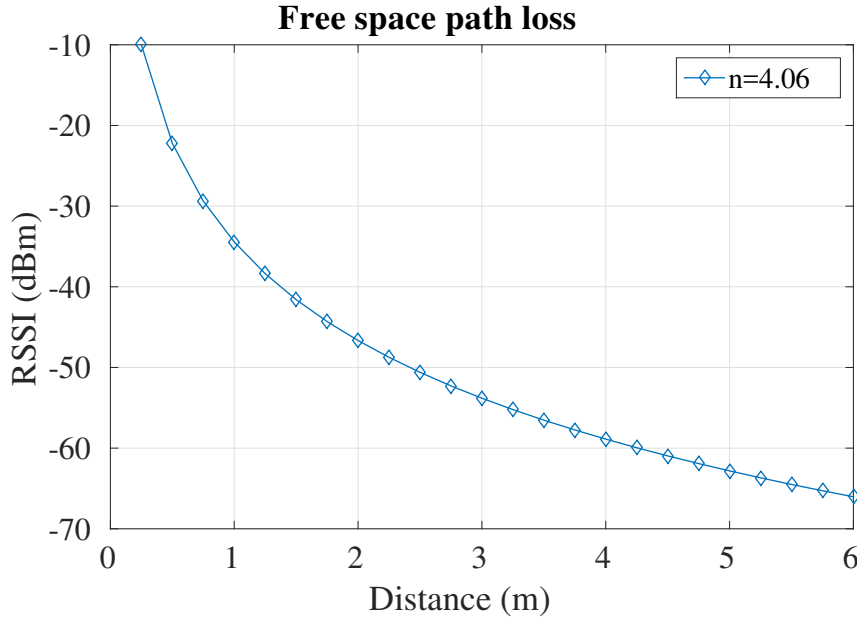
### **2.7.4 Scattering:**

Scattering occurs when the propagating RF wave impinges upon the objects whose dimensions are small (rough surfaces, street signs, lamp posts, foliage etc.) as compared to the propagating wavelength. Attenuation of RF wave occurs due to scattering which causes the variation in RSS.

### **2.7.5 Free-space model:**

Free-space model helps to predict the RSS when there exists a clear and unobstructed path between transmitter and receiver. The relation of the RSS that exists on distance is the inverse square law as presented in the Equation .2.4. The simulation for RSS vs distance in free space with path loss of 4.06 is shown in Figure .2.9.

Attenuation in this model is due to the energy that spreads on the way as the propagating wave moves further from the source, not due to the energy loss in the



**Figure 2.9:** Free space path loss model for n=4.06

medium.

### 2.7.6 Log-normal path loss model:

The literature in [Rappaport et al. (1996)] shows that received signal strength decreases logarithmically with distance as per the equation:

$$P_r(d) = P_r(d_0) - 10n \log\left(\frac{d}{d_0}\right) + X_\sigma \tag{2.6}$$

where  $X_\sigma$  is the zero-mean Gaussian distributed random variable in dB with standard deviation  $\sigma$  and  $n$  is the path loss exponent. Simulation of log-normal path loss model was performed for five values (within 3.5 to 5.28) is represented in the Figure .2.10.

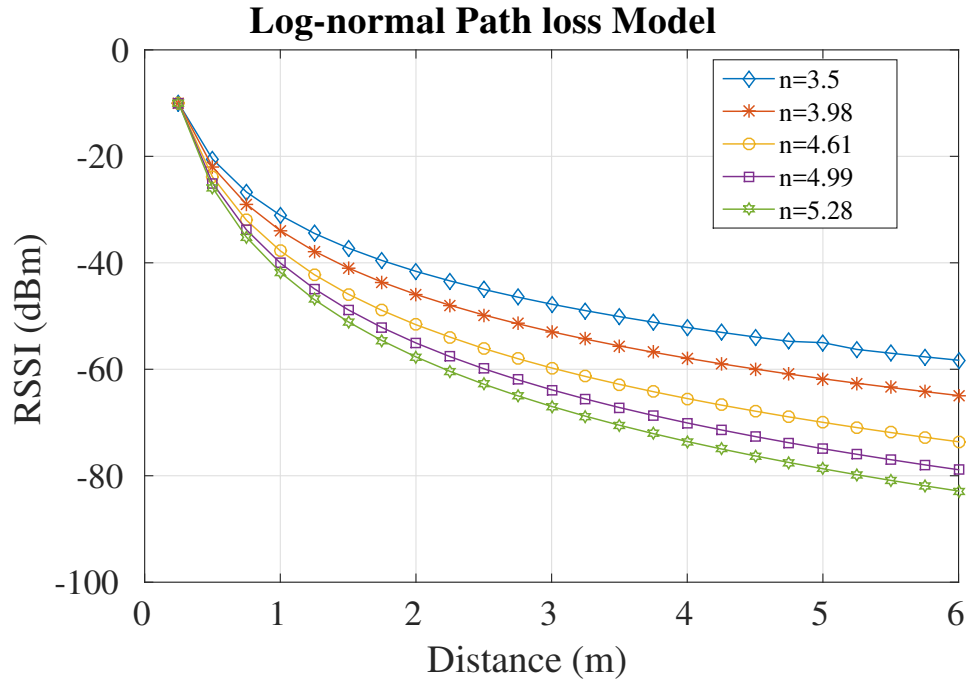


Figure 2.10: Log-normal path loss model for different values of  $n$

### 2.7.7 Related research:

In this section, relevant research on range-based position technique for wireless sensor network is reviewed. Several measurement techniques have already been discussed in (Mao *et al.*, 2007) and (Liu *et al.*, 2010).

#### 2.7.7.1 Localization Techniques

Localization [Moravek *et al.* (2013)] requires the absolute knowledge of the physical world without which location estimation is practically impossible. As per the diverse hardware capabilities, measuring techniques can be classified as in Fig. 2.11.

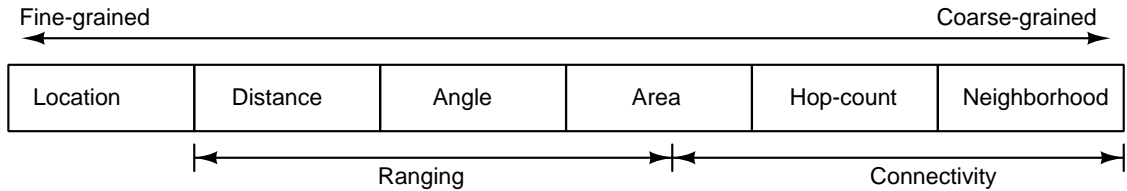
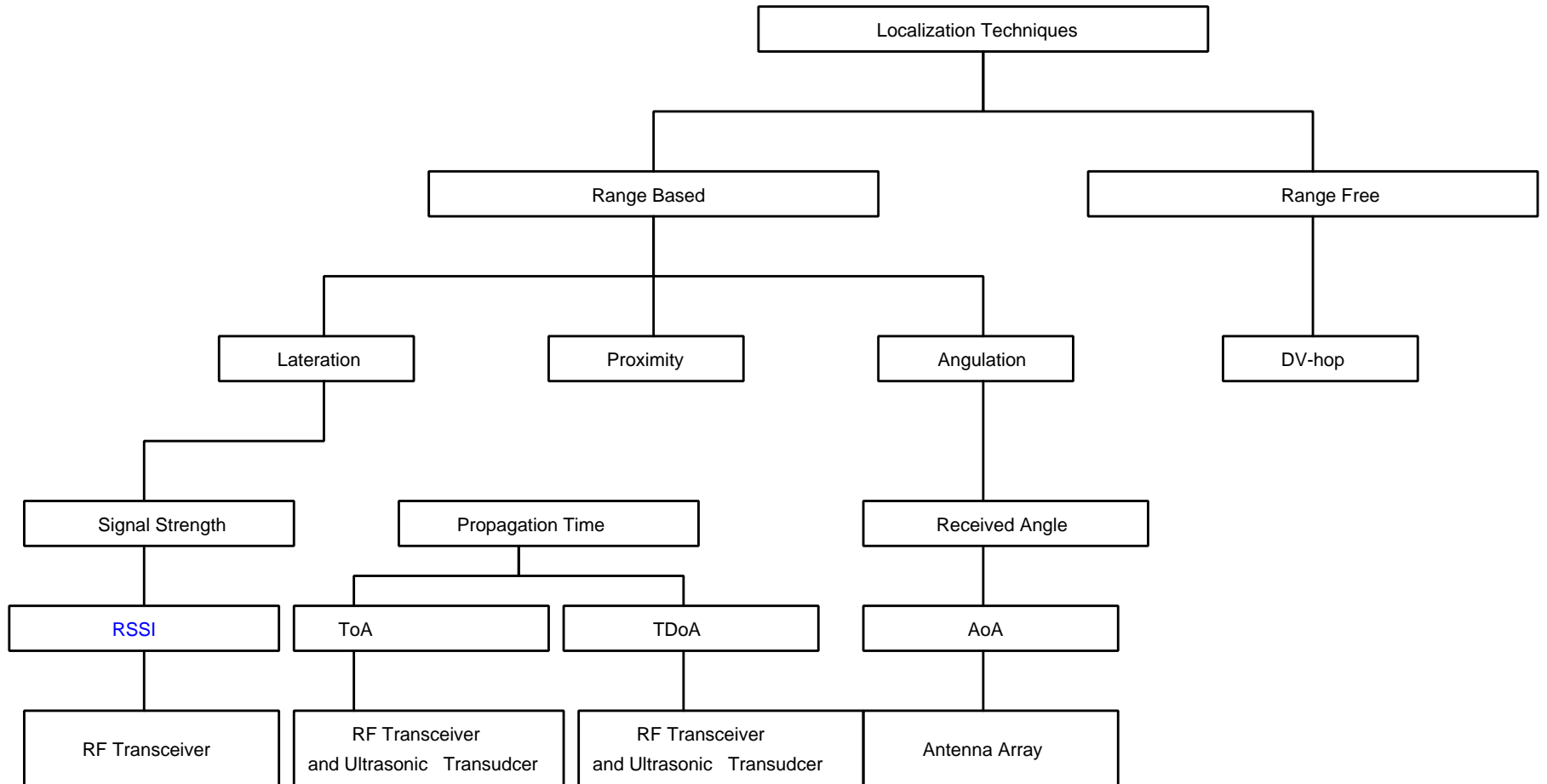


Figure 2.11: Physical Measurement

Classification of localization techniques is depicted in the Fig. 2.12.



**Figure 2.12:** Classification

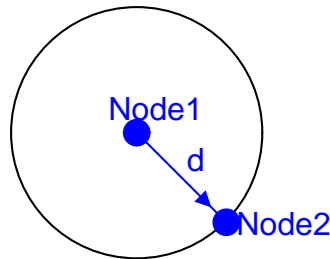
### 2.7.7.2 Range-based Localization Scheme

The concrete foundation, based on several localization approaches [Dargie and Poellabauer (2010)], is to estimate the distance within two sensors. Range-based scheme is based on the idea of distance estimation between unknown node and the anchor node. Where as range-free [Li (2013)] schemes estimates the location of unknown nodes without the knowledge of distance estimation. achieved by measuring particular characteristics of the signal exchanged, which includes Received Signal Strength(RSS), Time of Arrival(ToA) [Guvenc and Chong (2009)], Time Difference of Arrival(TDoA) and Angle of Arrival(AoA).

### 2.7.7.3 Time of Arrival(ToA):

ToA technique [Razul *et al.* (2011)] is mostly based upon accurate measurements of times of transmitted and received signals between two sensor nodes [(Li *et al.*, 2002), (Chen *et al.*, 2002), (Guvenc and Chong, 2009) and (Boukerche *et al.*, 2007)].

Distance information [Gezici (2008)] between two sensor nodes is provided by ToA, which estimates the flight time of a signal from one node to another. ToA estimation in the absence of error leads to an uncertainty region as shown in the Fig.2.13:



**Figure 2.13:** Circle of uncertainty

Based on propagation time and the speed of the signal, ToA is used for the estimation of the distance. These approach usually rely on synchronization. To calculate ToA for a signal between two nodes, a common clock is essential between two nodes or a protocol like two-way ranging protocol [Lee and Scholtz (2002)], [Sahinoglu and Gezici (2006)] which can give necessary exchanged time information.

Correlator or matched filter(MF) receiver [TURINT (1960)] is necessary for the estimation of ToA. Suppose one sensor node sends a signal  $s(t)$ , which is transmitted

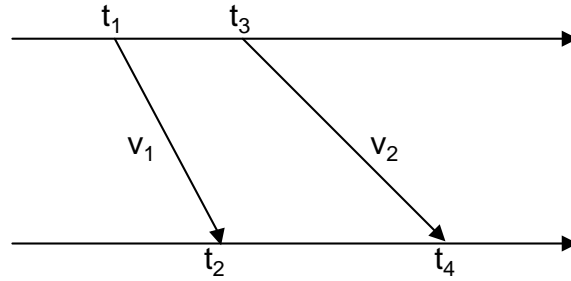
from to another node and the signal received by the receiver can be expressed as:

$$r(t) = s(t - \tau) + n(t) \quad (2.7)$$

where  $\tau$   $\rightarrow$  the Time of Arrival (ToA) and  $n(t)$   $\rightarrow$  Gaussian noise with zero mean and a spectral density of  $\frac{N_0}{2}$ .

#### 2.7.7.4 Time Difference of Arrival (TDoA)

Two signals which travel with different velocities are used for this TDoA approach [(Dargie and Poellabauer, 2010), (Lin *et al.*, 2013), (Sun *et al.*, 2013)] as shown in Figure .2.14:



**Figure 2.14:** TDoA

In the Figure .2.14, a radio signal is transmitted at the time  $t_1$  and is received at the time  $t_2$  which is followed by acoustic signal immediately or by some fixed time delay of  $t_{wait} = t_3 - t_1$ .

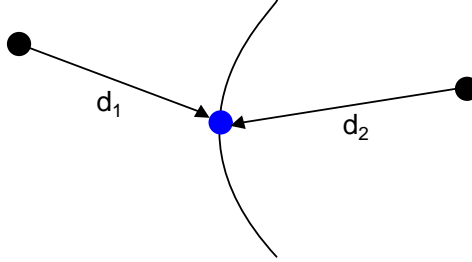
Hence the distance can be determined by the receiver as per the equation given below [Dargie and Poellabauer (2010)]:

$$dist = (v_1 - v_2) \times (t_4 - t_2 - t_{wait}) \quad (2.8)$$

TDoA estimation can be performed even in the absence of synchronization of clock between sender and receiver or target node and the reference node, if any synchronization exists between reference nodes [Caffery (2000)]. Arrival time difference estimation of two signals (propagating between the target node and the two reference nodes) is performed by TDoA, so as to determine the position location of the target node on



the hyperbola having two reference nodes at its focii as shown in the Figure .2.15.



**Figure 2.15:** TDoA measurement defining Hyperbola

Measurements of TDoA can be estimated by observing two separate sensors or by two ToA estimations of each sensor. Synchronization of the receivers is required in the former approach but synchronization between transmitter and receiver is essential for the latter approach.

Estimation [Gezici (2008)] of TDoA can be done by using the following equation:

$$\tau_{TDoA} = \hat{\tau}_1 - \hat{\tau}_2 \quad (2.9)$$

where  $\hat{\tau}_i \rightarrow$  ToA estimate for the signal (between target and  $i_{th}$  reference node).

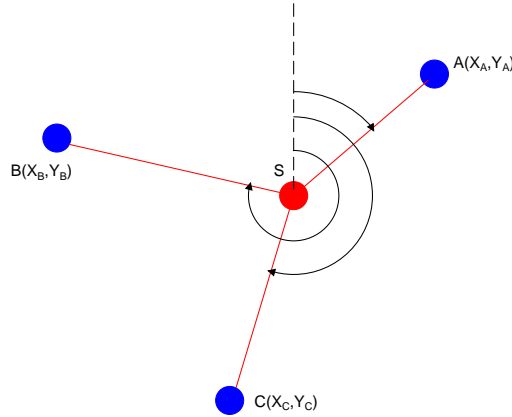
#### 2.7.7.5 Angle of Arrival measurement(AoA):

AoA (Visser, 2006) mostly rely on directional antennas or on multiple antenna configuration for the estimation of the angle of arrival of the received signal from the anchor nodes. The angle that exist between some referred direction to the propagated direction is known as Angle of Arrival.

The Figure .2.16 shows a general scenario for angle of arrival:

High accuracy in localization based upon measurement is possible in Angle of Arrival approach for which we require antenna arrays (Visser, 2006) with certain spacing for spatial diversity having higher complexities to measure the required direction. For specific WSNs , it may not be feasible to get that much spacing between arrays by considering the size of sensor nodes.

In the papers (Niculescu and Nath, 2003a) and (Peng and Sichitiu, 2006), authors have depicted the AoA scheme in which sensors forward their bearings with respect to



**Figure 2.16:** Angle of Arrival

anchor nodes i.e sensor nodes assume the awareness of their own coordinates as well as orientations. The paper [Kucuk *et al.* (2008)] depicts the use of adaptive antennas with anchors for communication with the sensors deployed in different places of wireless sensor networks. Another paper [Qu and Wicker (2006)] takes the assumption that bearing angle is being sent by the sensor placed at the center of the network and with this aid of the bearing along with some more information with some RSS data, calculations of coordinates are done by other correcting sensor nodes. In reference (Lazos and Poovendran, 2005), anchor nodes with sectored antennas are depicted where intersection of antenna sectors of different anchor nodes determines the position of sensor nodes. The paper [Elnahrawy *et al.* (2007)] depicts that reception of AoA information from anchor nodes is exact, which can possibly be accomplished with the anchor nodes having directional antennas, whose rotation is constant with respect to angular speed. But as the small sensors have large rotating antennas which is infeasible for some applications, led to the adaption of the idea regarding lighthouse approach (Römer, 2003). Always achieving the good accuracy in AoA localization has become the main challenge.

In general, at least four stationary antennas which have anisotropic antenna patterns is used [Koks (2007)] to solve the varying signal strength problem.

#### 2.7.7.6 Received Signal Strength (RSS) :

Here shadowing model is used for distance estimation between anchor node and the unknown node with the help of received signal strength and coordinate is calculated by trilateration method in which three or more anchor nodes are neces-

sary. In many projects (Kloos *et al.*, 2006), (Bahl and Padmanabhan, 2000), parameter RSS have been used. Some hardware constrained studies (Vander Stoep, 2009), (Whitehouse *et al.*, 2007), (Kuo *et al.*, 2005) and (Patwari and Hero III, 2003) have shown that use of RSS for localization purpose have been quite useful. In these RSS models RSS have been mapped to the distance.

As per the above depiction of the three methods (i.e. ToA, TDoA and AoA), it is obvious that RSS based technique possess much more advantages which includes no/less requirement of extra hardware with less complexity and cost.

Indoor positioning mostly rely on RSS based technique and has been used widely. Jeffrey Hightower and Gaetano Borriello [Hightower *et al.* (2000)] proposed 3D location sensing which was based on RSS analysis. Xinrong Li [Li (2006)] has proposed a RSS based joint estimation of unknown location coordinates in changing environment. Here they have used the combination of distance-power gradient, a parameter of path loss model and RSS based location estimation. Authors were able to eliminate the need for extensive modeling and channel measurement. Also, it optimizes the performance in different environment.

Heikki Laitinen *et al.* [Laitinen *et al.* (2007)] used narrowband measurements at five VHF frequencies to evaluate the accuracy of RSS-based location algorithms. They have used kalman filter on estimated coordinates to eliminate largest location errors. Shuang Tian *et al.* [Tian *et al.* (2007)] proposed RSSI-based DV-hop algorithm, where they have incorporated the advantages of range-based as well as range-free methods which have improved the accuracy as compared to the previous algorithms. Giovanni Zanca *et al.* [Zanca *et al.* (2008)] investigated the performance comparison of different localization algorithm. Here authors have focused on RSS based measurements only for comparison.

Jia Chen *et al.* [Chen *et al.* (2009)] proposed an improved RSSI-based algorithm for a park light control and children location tracking system. Here, they have established piecewise linear path loss model, where only linear operation was required for RSSI based range estimation. Jiuqiang Xu *et al.* [Xu *et al.* (2010)] proposed a method which illustrates the relationship function of RSSI variance and distance. Based upon this they have established the log-normal shadowing model where variance can be adjusted dynamically. Their proposed method has proved that it has self-adaptability to various environment.

Chen Feng *et al.* [Feng *et al.* (2012)] proposed an RSS based indoor positioning

system which uses compressive sensing that recover sparse signals from noisy environment by solving  $l_1$  minimization problem. Linlan Liu et al. [Liu *et al.* (2013)] proposed a 3D range-free localization, named as hexahedral, where space is divided into a lot of hexahedrons. Here, by simulation they were able to achieve high accuracy. Mukhopadhyay et al. [Mukhopadhyay *et al.* (2014)] proposed a technique which combines (mean + filter), mode, (mode + filter), to evaluate RSS for indoor localization. El Assaf [El Assaf *et al.* (2015)] proposed a localization algorithm which is used for anisotropic wireless sensor network. The developed algorithm can be used for both 2D as well as 3D scenarios.

Luo et al. [Luo *et al.* (2016)] proposed a method for improved RSSI-based localization which makes use of the uncertain data mapping. Further they determined RSS data tuples and applied a strategy which matches the data tuple patterns to RSS data vector for localization. Lee et al. [Lee *et al.* (2017)] proposed a location tracking method which uses RSS values received from Bluetooth Low Energy beacon. A method have been imposed to reduce the noise generated in the environment by the use of double gaussian filter.

#### **2.7.7.7 Comparison of Localization methods:**

Table 2.1, Table 2.2, Table 2.3, Table 2.4 shows the comparison between various methods. It depicts that the methods which we choose will be primarily dependent upon the application requirement, availability of resources as well as on the correcting scenario, as the choice of choosing a method for an application put much impact on the performance of the system which is localized.

**Table 2.1:** Comparative analysis of different Localization methods (2000-2007)

Author, Journal, Year Reference	Paper Description	Context Used	Methods	Performance	Future Scope
Jeffrey Hightower et al, UW CSE 00-02-02, 2000 Hightower <i>et al.</i> (2000)	Dynamic fine-grained localization in ad-hoc networks of sensors	Localization, wireless sensor network, Received signal strength	Ranging characterization, localization Algorithm, atomic multilateration.	localization was estimated.	extend the algorithm for better accuracy
Andreas Savvides et al, ACM, 2001 Savvides <i>et al.</i> (2001)	An Indoor 3D Location Sensing Technology Based on RF Signal Strength	Location sensing, positioning, signal strength	AIR ID Analysis, Aggregation Algorithm	Tag Location was determined.	Any robust and scalable location sensing architecture needs to develop a data model
Mihail L Sichitiu et al, IEEE, 2004 Sichitiu and Ramadurai (2004)	Localization of wireless sensor networks with a mobile beacon.	Localization, beacon RSSI	Radio Frequency(RF) based,	Algorithm scales to any number and density of unknown nodes with the use of single mobile beacon.	Accuracy can be improved
Xinrong Li et al, IEEE Transaction, 2006 Li (2006)	RSSI based location estimation with unknown pathloss model	Cramer-Rao Bound, Least Square Estimation, location estimation, RSSI	RSS based joint estimation, Non-linear square estimator	unbiased RSSUDPG estimators are more sensitive to geometric parameters than unbiased RSS estimators.	careful planning of reference node deployment
Bo-Chieh Liu et al, IEEE Transaction, 2006 Liu <i>et al.</i> (2006)	Hyperbolic and circular positioning algorithm using stationary signal strength difference measurements.	circular positioning algorithm, hyperbolic positioning algorithm, signal strength diff.	Relative signal strength measurement,	hyperbolic and circular positioning algorithms can locate the user within 350 and 300m in 67 percentile estimators.	investigate the effect of combining technologies for better accuracy.
Masashi Sugano et al, Target, 2006 Sugano <i>et al.</i> (2006)	Estimation of distance by measuring RSSI at an appropriate no of sensor nodes	performance evaluation, localization, RSSI, ZigBee	autonomous indoor localization system	position estimation error was reduced to 1.5-2 m	verification of practicality of position sensing technique of more targets with
Bruno Betoni Parodi et al, IEEE, 2006 Parodi <i>et al.</i> (2006)	RSS maps for indoor/campus localization.	Localization, RSS, online learning, ZigBee	two-field approach	good localization precision can be achieved with very low installation and maintenance cost.	further tests are needed to make possible a parameter self-tuning.
Heikki Laitinen et al, IEEE Transaction, 2007 Laitinen <i>et al.</i> (2007)	Experimental evaluation of location methods based on Signal Strength measurements.	Kalman-filtering, Location estimation and accuracy, radio propagation and RSSI.	narrowband measurement at five VHF frequencies are used to evaluate accuracy of RSS based location algorithm.	combination of an unbiased propagation model and LS algorithm provided accurate RSS based location.	Accuracy can be increased.
Shuang Tian et al, IEEE, 2007 Tian <i>et al.</i> (2007)	Proposed RSSI based DV-hop algorithm	DV-hop, Localization, RSSI and wireless sensor network	DV-hop algorithm	Estimation error in network was reduced.	Localization of more nodes and to increase the localization accuracy.

**Table 2.2:** Comparative analysis of different Localization methods (2008-2010)

Author, Journal, Year Reference	Paper Description	Context Used	Methods	Performance	Future Scope
Giovanni Zanca et al, ACM, 2008 <i>Zanca et al. (2008)</i>	Experimental comparison of RSSI-based localization algorithms for indoor environment.	Localization, testbed, RSSI and wireless sensor network	testbed	how the localization precision is affected is analyzed.	Localization accuracy needs to be increased.
Charalampos Papamantou et al, Springer, 2008 <i>Papamantou et al. (2008)</i>	Formulation of probability distribution of the position of the sensor nodes	Beacon, Location estimation, RSSI	Probability distribution	Correct probabilistic distribution of sensor location is computed.	Accuracy can be increased with the increase in number of samples.
Paolo Barsocchi et al, IEEE, 2009 <i>Barsocchi et al. (2009)</i>	Selects and weights RSSI, localization is achieved with the help of a specific propagation model.	Localization algorithm, RSSI, propagation model	Global virtual calibration, Per-wall virtual calibration	Based on anchor density improved algorithm performance was achieved with good accuracy	Better accuracy can be achieved.
Mark Barralet et al, IEEE, 2009 <i>Barralet et al. (2009)</i>	Affects of polarization on accuracy of indoor location tracking system.	RSSI, polarization	Range measurement, polarization mismatch	experiment has verified that range measurement is affected by antenna which in turn affects localization	Localization accuracy can be increased.
Jia Chen et al, IEEE, 2009 <i>Chen et al. (2009)</i>	RSSI based localization algorithm for park lighting control and child location tracking.	RSSI, location tracking	Piecewise linear path loss model, MLE estimation	control the various lamps inside the park and tracking of the child was achieved.	Locating accuracy is to be improved.
Jiuqiang Xu et al, SciRes, 2010 <i>Xu et al. (2010)</i>	A LNSM-DV model was proposed based on relationship function between RSSI and distance to improve accuracy	LNSM, Dynamic Variance (DV), RSSI Distance measurement	Least square method is used with LNSM	Error is reduced by LNSM-DV with strong self-adaptability	Research on layout of nodes can be done with the help of LS and LNSM-DV
Zhongwen Guo et al, IEEE Transactions, 2010 <i>Guo et al. (2010)</i>	Perpendicular Intersection (PI) method for locating wireless sensors	Localization, mobile beacon, Perpendicular Intersection	Perpendicular Intersection	PI exploited the geometric relationship between node and the trajectory of mobile beacon tolerating irregularity of RSSI signals.	research of the scheme optimization.

**Table 2.3:** Comparative analysis of different Localization methods (2012-2013)

Author, Journal, Year Reference	Paper Description	Context Used	Methods	Performance	Future Scope
Chen Feng et al, IEEE, 2012 Feng <i>et al.</i> (2012)	RSSI based positioning using compressive sensing	indoor positioning, fingerprinting, clustering, radio map, WLANs	Compressive sensing, a method to recover sparse signal from noisy measurements.	Re-construction of radio-map from measurement at a small no of fingerprints.	More analysis on density is required for accurate positioning system
Linlan Liu et al, Hindawi, 2013 Liu <i>et al.</i> (2013)	Hexahedral(HL) localization	RSSI, mobile beacons localization	Least square method, trajectory	HL is relatively perfect in accuracy	Model optimization
Dieng et al, IEEE, 2013 Dieng <i>et al.</i> (2013)	Approach for localization using ML estimator on two modes Gaussian mixture model	LNSM,Dynamic Variance (DV),RSSI Distance measurement	Least square method is used with LNSM	Error is reduced by LNSM-DV with strong self-adaptability	Research on layout of nodes can be done with the help of LS and LNSM-DV
Ndubueze Chuku et al, IEEE, 2013 Chuku <i>et al.</i> (2013)	RSSI based localization scheme mitigate the shadowing effect	Localization, moving beacons	Localization of unknown node is done by the use of peak of bivariate Gaussian mixture	Effect of erroneous distance calculations in node localization in the presence of obstacles is negated	Proposed scheme can be implemented in large life monitoring env.
Z Mary Livinsa et al, IEEE, 2013 Livinsa and Jayashri (2013)	RSSI based localization algorithm to measure better distance estimation	Distance estimation, Trilateration, RSSI	Trilateration method is used to reduce error accumulation	Outdoor environment give better distance estimation than indoor environment with minimum localization error.	Localization error can be further minimized
Attila Buchman et al, IEEE, 2013 Buchman and Lung (2013)	Room level accuracy in indoor environment is achieved by the use of already deployed WLAN	Covariance, Received signal strength	Passive scanning of access points, fingerprinting	Covariance based method to achieve room level accuracy	Large number of test needs to be conducted with different devices in indoor environments
K Vadivukkarasi et al, Citeseer, IJRTEET 2013 Vadivukkarasi and Kumar (2013)	Distance estimation using RSSI	Localization Received signal strength, power level anchor node	Trilateration	Improved RSSI method with average 36 percent error reduction	Error in localization can be further reduced
Adewumi et al, IEEE, 2013 Adewumi <i>et al.</i> (2013)	Distacne estimation by RSSI model	WSN, RSSI, Distance Localization	LNSM is used for distance estimation	Path loss exponent factor is less in outdoor environment as compared to indoor environment.	Accurate algorithm can be developed for localization.
Safa Hamdoun et al, IEEE, 2013 Hamdoun <i>et al.</i> (2013)	position error is evaluated	Indoor localization, WSNs, multipath fading, shadowing, RSSI, accuracy, antenna	multilateration, trilateration, Localization	Localization performance is improved using multiple antenna.	Models can be evaluated using real experimentation.
Long Xiao et al, Radioengineering, 2013 Xiao <i>et al.</i> (2013)	off-the-shelf active RFID technology	Indoor localization, Gaussian Filter, wheel graph, probabilistic localization algorithm	Average localization distance error algorithm is used to evaluate positioning error.	Increased recursion time will lead to higher localization accuracy.	uncertainty of localization can be further reduced.

**Table 2.4:** Comparative analysis of different Localization methods (2014-2017)

Author, Journal, Year Reference	Paper Description	Context Used	Methods	Performance	Future Scope
Mengmeng Gai et al, IEEE, 2014 Gai and Azadmanesh (2014)	indoor localization of a mobile object equipped with sensors and cameras	Wireless sensor network, Building information modeling, Sensor Area localization, stereo vision	Building Information Modeling and 3D stereo image measurements	RSSI based measurement is used for localization. te determined DMS, location was found by image matching algorithm and distance measurement technique.	Accuracy and speed of localization can be further achieved.
Bai Si-qi et al, IEEE, 2014 Si-qi <i>et al.</i> (2014)	Higher positioning accuracy by the use of method which dynamically correcting PLE	PLE, RSSI, Indoor Location correcting method modeling, Sensor Area localization, stereo vision	PLE correction algorithm	PLE correction algorithm has higher accuracy and environmental adaptability than traditional algorithm	Positioning Accuracy can be further achieved.
Bodhibrata Mukhopadhyay et al, IEEE, 2014 Mukhopadhyay <i>et al.</i> (2014)	Evaluation of RSSI is performed by the use of mean+filter, mode and mode+filter for accurate indoor localization	RSSI, Localization	mean+filter, mode and mode+filter	mode + filter technique reduces error by 64.76 percent and mean + filter reduces error by 54.95 percent.	RSSI technique can be integrated with RAPIDSNAP
Yan Huang et al, Hindawi Publishing Corporation, 2015 Huang <i>et al.</i> (2015)	Influence of RSSI ranging error on position accuracy, developed a robust localization algorithm.	RSSI, Localization ranging	One to one mapping between RSSI and distance scope based on path loss exponent.	Proposed Localization algorithm based on one-to-one mapping is more accurate than the use of fixed parameter method.	Improvement in accuracy can be achieved.
El Assaf et al, Hindawi Publishing Corporation, 2015 El Assaf <i>et al.</i> (n.d.)	Localization algorithm for anisotropic wireless sensor network	Localization, Distance estimation	Reliable anchor selection strategy, distance estimation technique.	Range-free localization algorithm is tailored for anisotropic wireless sensor network.	Improvement in accurate localization can be achieved.
Zhe Chen et al, CRC Press, 2015 Chen <i>et al.</i> (2015)	Modified RSSI localization algorithm is proposed based on tangent lines on circles to increase localization precision.	Localization, RSSI	Bounding box algorithm, Tangent line of circle algorithm.	Variance of noise is about 1.12 times of the mean actual distance.	Accuracy in localization needs to be improved.
Luo, Qinghua et al, IEEE Sensors Journal, 2016 Luo <i>et al.</i> (2016)	RSSI based localization through uncertain data mapping	Localization, mapping, uncertain data	Mapping based, uncertain data matching algorithm.	Higher accuracy in environment with high level of uncertainty.	Better Accuracy in can be achieved.
Lee et al, KSII Transactions, 2017 Lee <i>et al.</i> (2017)	Location tracking system using BLE beacon exploiting double Gaussian filter.	Location tracking,	BLE Beacon, Double Gaussian filter.	Reduction in error was achieved. high level of uncertainty.	To conduct additional experiments for accurate and effective result.



A typical comparison [Boukerche (2008), Boukerche *et al.* (2007)] of various methods which is used for distance/angle estimation between two nodes are given in the Table 2.5.

Time-based methods as ToA etc., are mostly dependent upon synchronization. AoA cannot be a choice as it requires extra hardware (not cost-effective). So adapting RSSI based distance estimation for localization would be appropriate without any need of extra hardware or need for synchronization.

Among several approaches, RSSI based distance estimation has become a vital approach for distance estimation as well as for localization of the object as it does not require any extra hardware for implementation.

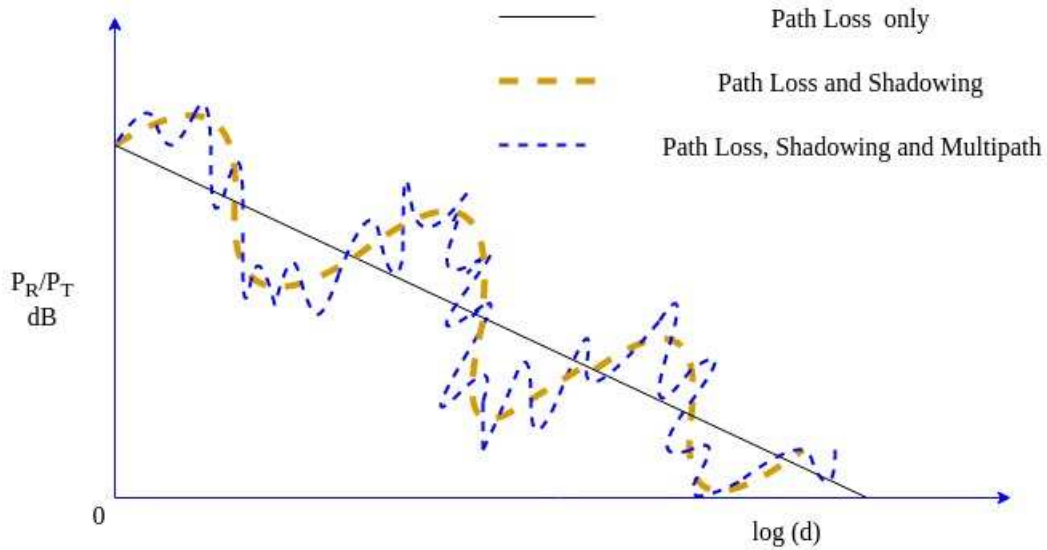
**Table 2.5:** Comparison of methods

Method	Precision Measurement	Maximum distance	Requirement of Extra Hardware	Challenges
RSSI	Meters(2-4m)	communication ranges	None	RSSI variation, interferences
ToA	centimeters (2-3 cm)	communication ranges	None	synchronization of Node
TDoA	centimeters (2-3 cm)	few meters (2-10 m)	ultrasound transmitter	work distance is maximum
AoA	A few degrees	communication ranges	Set of receivers	for small sensors

### 2.7.8 RSS Issue:

Due to the presence of obstacles in the direction of propagation, signal fades and loses its strength. Performance of the system will degrade as the transmission path changes from the LoS condition to the obstructed condition by several obstacles such as wooden furniture etc., which provides Non-LoS path. In free space propagation, where there exists a clear LoS path between transmitter and receiver, follows the equation 2.4. Attenuation of signal depends upon various factors such as Path Loss

and Shadow Fading (Figure .2.17 [Rappaport et al. (1996)])in large scale propagation and fading model in small scale.



Electromagnetic Wave

**Figure 2.17:** Path loss, Shadowing and multipath

### 2.7.8.1 Path Loss:

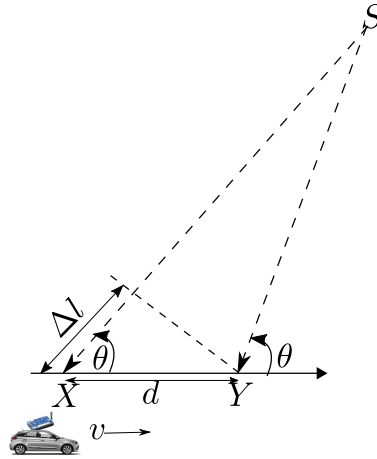
The signal which is emitted from the transmitter traverse a distance to the destined receiver. Within due course of propagation, signal strength decreases with increasing distance. The loss obtained due to the propagation of the signal in space is termed as Path Loss. It is the reduction in power density of the electromagnetic wave as it traverse through the environment. Several factors such as free-space loss, reflection, diffraction, absorption etc., as well as distance between the  $T_x$  and  $R_x$  and the height of the  $T_x$  are responsible for Path Loss. Simulation of path loss has been represented in subsection 2.7.5 and subsection 2.7.6. There is also a possibility that the propagated signal may travel along different as well as many paths to reach the receiver which is known as multipath. Path Loss is represented by Path Loss Exponent (PLE) whose calculation will be discussed in Chapter IV subsection 4.1.2.1. PLE ranges from 2 to 6 and is usually expressed in dB.

### 2.7.8.2 Fading:

Rapid fluctuation in amplitude, phase as well as multipath over a short distance or time, happens in small scale fading. As analysis of the signal propagation is performed over short distance or time, effects of large scale is ignored. Due to existence of multipath, the fading effect occurs. As a result, change in received signal strength occurs over a small instance of time. Even random frequency modulation occurs due to Doppler effect (Figure .2.18)for each of the multipath. Difference in the path length which is traveled by the electromagnetic wave from source S to the point X and Y is given as:

$$\Delta l = d \cos \Theta = v \Delta t \cos \Theta \quad (2.10)$$

where  $\Delta t$  is the time taken by the mobile sensor to move from X to Y and phase

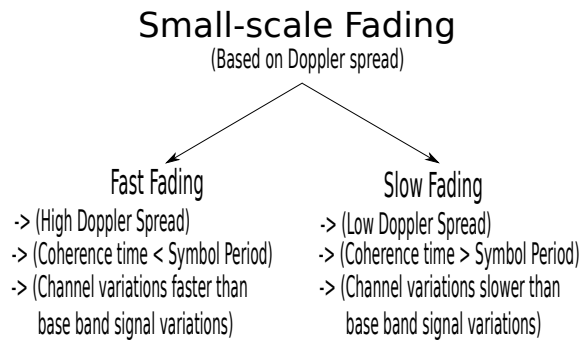
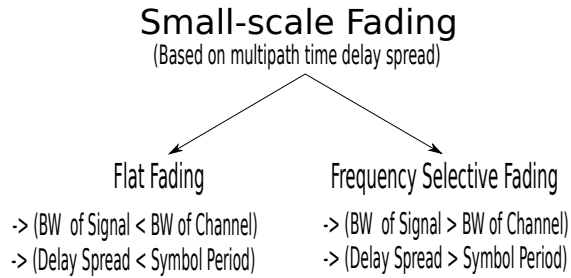


**Figure 2.18:** Doppler effect

change in the received signal due to the path length difference is :

$$\Delta \Phi = \frac{2\pi \Delta l}{\lambda} = \frac{2\pi v \Delta t}{\lambda} \cos \Theta \quad (2.11)$$

Classification of small-scale fading based on multipath time delay and doppler spread is shown in Figure .2.19. As per the Figure .2.19, multipath time delay spread leads to Flat Fading and frequency Selective Fading. Similarly doppler spread leads to Fast Fading and Slow Fading. These two mechanisms are not dependent on each other (Rappaport et al., 1996).



**Figure 2.19:** Classification of Small-scale fading

### 2.7.9 RSS limitation and challenges

As per the Figure .2.9, strength of propagated signal reduces by several factors such as path loss, fading, shadowing etc., (Heurtefeux and Valois, 2012). When the signal is propagated through space, power of the signal is reduced which is termed as path loss ( $n$ ). The value of  $n$  varies in different environments. Deviation of the attenuation in a signal is termed as fading whereas loss of the propagated signal between transmitter and receiver, due to the presence of several obstacles such as walls, buildings etc., is termed as shadowing. One of the most important factor for the shadowing is, movement of the people within the region of operation in an uncertain manner (variation upto -21 dB).

Received signal strength possess some limitations with respect to distance:

- RSSI-distance ratio is varies (min and max RSS values)in different platform.
- For bidirectional link, RSS can be asymmetric.

- Anisotropic radiation behavior.
- Link quality in terms of RSS.

Based upon the above characteristics, RSS have some challenges in terms of accuracy and stability. Hence to improve accuracy some of the features need to be taken into consideration:

- RSS needs to be measured over several operating frequencies.
- For smooth variations, average of RSS values need to be considered.
- Sensor radio needs precise calibration.
- Quality of the sensor antenna must be good.
- Interference must be minimized.

### **2.7.10 Problem overview**

As the primary focus on this work is on wireless sensor networks operating in indoor environment, GPS cannot be used. Hence, RSS based technique in localization is a good alternative. But, RSS is noisy, varies with several environmental factors, unstable and challenging to use in practice. Hence, intensive study is essential to understand the nature of RSS behavior and its dependencies. In reference to these, some problems with higher priority are:

- Selection of sensors from a group of sensors which have almost similar characteristic for RSS is essential for distance estimation as well as for localization.
- Detailed investigation of RSS behavior at several distances in dynamic indoor environment is not done. Hence for distance estimation and localization, thorough analysis of the RSS behavior in various environmental conditions is required.
- In general, log normal path loss model for received signal strength based localization, excludes the influence of several factors such as transmitted power level, radio channels etc., on RSS. Hence there is a need for specific model for wireless sensor network.

- Various published research work on RSS based localization is simulation based rather than real-time experimented work. Simulation based work considers the RSS uncertainty as statistical quantity instead of detailed investigation. Hence there is a need for detailed experimental study.

Hence, investigating the above problems is of primary task to use the RSS efficiently for distance estimation as well as for localization.

## Chapter 3

# Experiments on factors influencing the RSS.

In chapter 3, several factors that influences the received signal strength are identified and series of real field experiments are performed to analyze the impact of the factors on RSS. The RSS-distance relationship between the transmitter and receiver are analyzed with respect to the variation in transmitter position, change in the operating frequency, change in height of transmitter and receiver as well as variation in the environmental specifics. Among so many proposed localization algorithms, methods based on RSS attenuation has been considered for this dissertation.

## 3.1 Introduction

Location of an object is estimated by using ToA, TDoA, AoA and RSS attenuation. Here in this dissertation work, RSS attenuation with respect to distance is used. Now in almost all the sensor nodes available in the market, have a standard feature which obtains the received signal strength by message [(Yedavalli *et al.*, 2005), (Stoleru and Stankovic, 2004)].

In [Foong *et al.* (2006)], authors have presented how the RF signals behave in the environment where reflection occurs with obstacles present in between the transmitter and receiver. They have collected RSS samples to evaluate, how RSS behaves under the influence of environmental changes. Their results and analysis report how RSS is dependent upon environmental specifics such as reflection etc.

In this thesis, indoor environment means the unobstructed, clear line of sight path as well as obstructed and non-line of sight path environment. Necessity of received signal strength based localization demands more detailed investigation with large amount of data. Some of these conditions include:

- distance from 0 to 6 m.
- different frequencies at 2.4 GHz band.
- mobility of the receiver etc.

The following subsection of this chapter, depicts the identification and analysis of the factors that influence the RSS. Series of experiments were performed using tiny IRIS sensors and moteview software. The relation that exists between RSS and transmitter-receiver distance will be analyzed with the presence of obstacles and environmental specifics.

## 3.2 Sources of RSS variability

Received signal strength varies frequently with the environmental changes, as a result it becomes highly unstable. So the sources due to which RSS variation occurs, needs to be identified and considered, when RF propagation modeling is necessary for sensors to be deployed for localization.



### 3.2.1 Factors related to sensor hardware:

The factors which are related to the sensor node hardware manufacturing are operative radio frequencies, range in RSS accuracy, etc. Some of the factors which come under this category are :

- operating radio frequencies.

IRIS sensor nodes operates in 2400 MHz band (2405 MHz - 2480 MHz) each frequency separated by 5 MHz. Antenna behaves differently for different frequencies which results in the received signal strength variation.

- transmitter power level.

Variation in transmitter power level causes variation in received signal strength. However variation in power level and received signal strength may be non-linear in nature. Use of low transmitter power is not reliable in some application point of view. Hence there is always a trade-off between transmitter power level and reliability.

- transceiver variation.

Even if there is uniform initialization of all the antennae, still there is difference in behavior that occurs due to the manufacturing tolerance for the sensor hardware. Sensitivity of the IRIS receivers is -101 dBm (typical).

- RSS values.

Uncertain values in RSS increases due to several factors such as internal noise present inside the system hardware, communication link (incomplete) etc. Accuracy in RSS indicators have a vital role as it varies with the fluctuation in received signal strength.

### 3.2.2 Factors related to the environment

- Height of the transceiver.

The moment we increase the height of the transceiver, reflection from the ground comes into picture. Here direct and reflected RF wave collide each other, either constructively or destructively causing fluctuation in RSS, either in sharp increasing or decreasing manner.

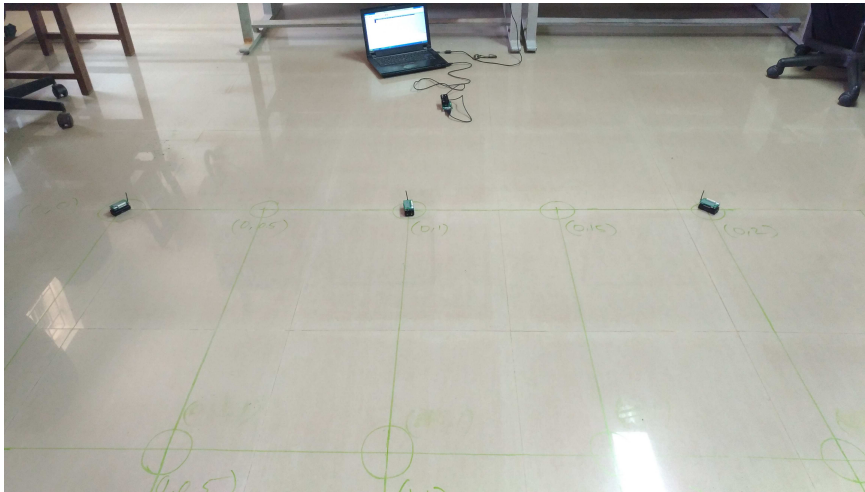
- Specifics related to the indoor environment.

Mechanisms such as reflection, diffraction and scattering provides obstruction most of the time with in the transmitter and receiver, which in-turn is the cause for received signal strength variation.

### 3.2.2.1 Radio Frequency:

As IRIS sensor nodes operates in 2.4 GHz band (2405 MHz - 2480 MHz), tests are performed to verify whether RSS is different for different frequencies for same transmitter power.

**Experimental setup** The network area used for the experimental purpose is a fixed  $M \times N$  area with length  $M$  (6 m) and width  $N$  (3 m) and  $K$  (5) number of sensors. The real field deployment of sensors in the lab is shown in the Figure .3.1



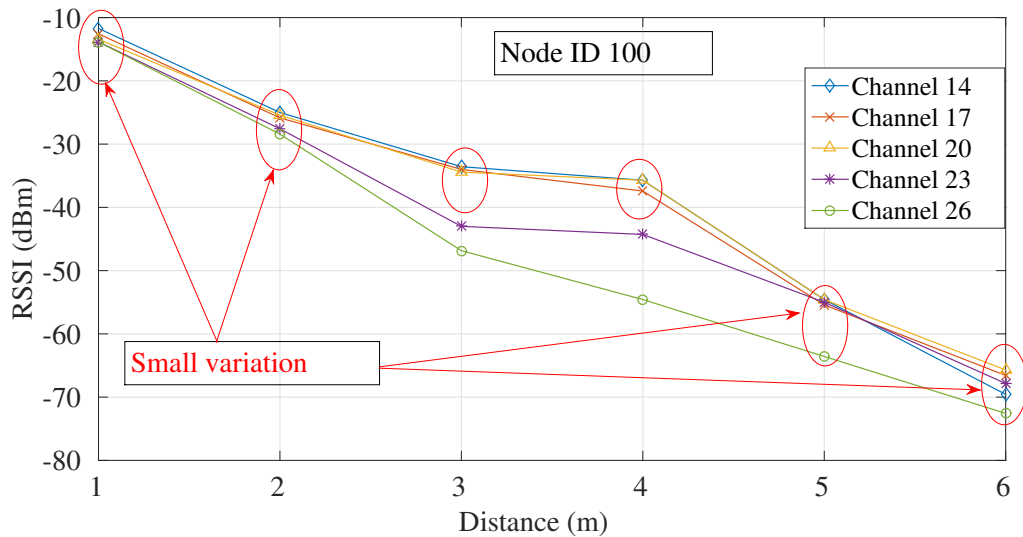
**Figure 3.1:** Sensor Network deployment

The assumptions for the experimental work was defined :

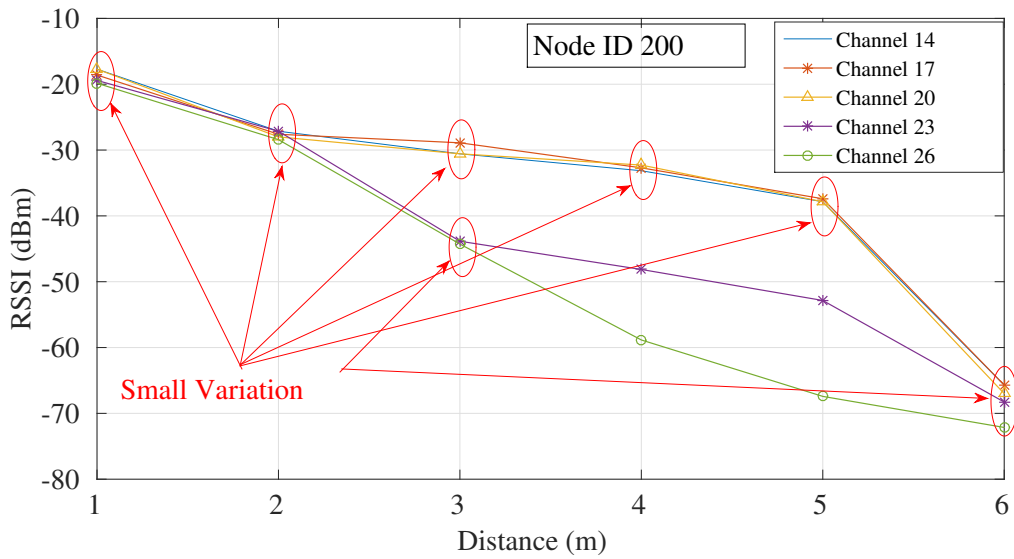
- Sensors were placed in different indoor environment.
- Maximum no. of sensor nodes were set to be 5.
- RSS was received by the Base Station.
- 2D architecture was used for experiment.
- Sensors placed in the indoor environment were static.

- Homogeneous sensor nodes were used as they possess the same transmission range as well as the same initial energy.
- As we are using the static model, location of the anchor sensors and the BS remained unchanged.

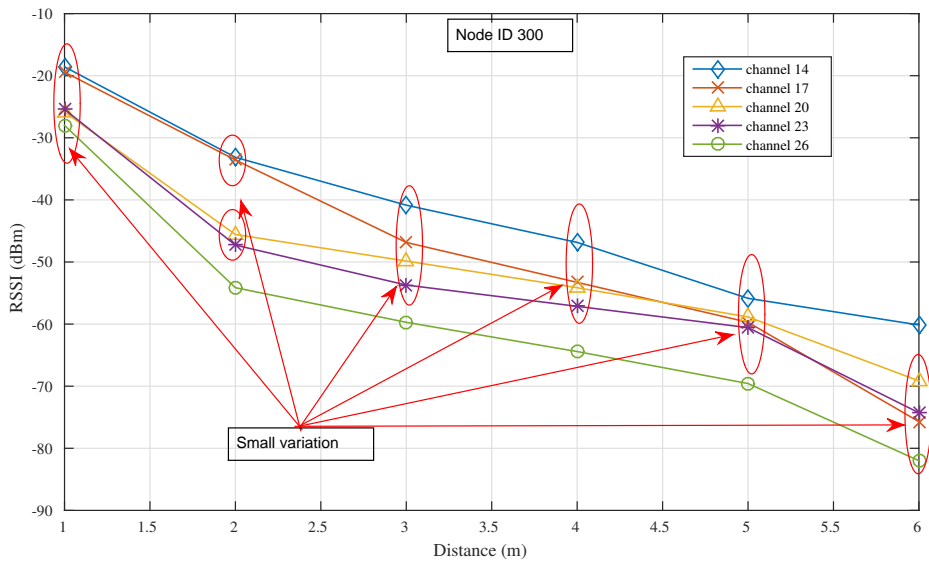
ZigBee and the IEEE 802.15.4 have divided the band of 2.4 GHz into 16 channels (i.e 11 to 26). As wavelength is different for different RF channels, RSS gets influenced with the variation in wavelength. In the Figure .3.2, Figure .3.3, Figure .3.4, different sensor nodes were used to send RSSI and five different frequency channels (i.e Channel 14, Channel 17, Channel 20, Channel 23, Channel 26), among 16 channels as discussed above were used as test frequency bands.



**Figure 3.2:** RSSI measurement at Node ID 100 with various channel

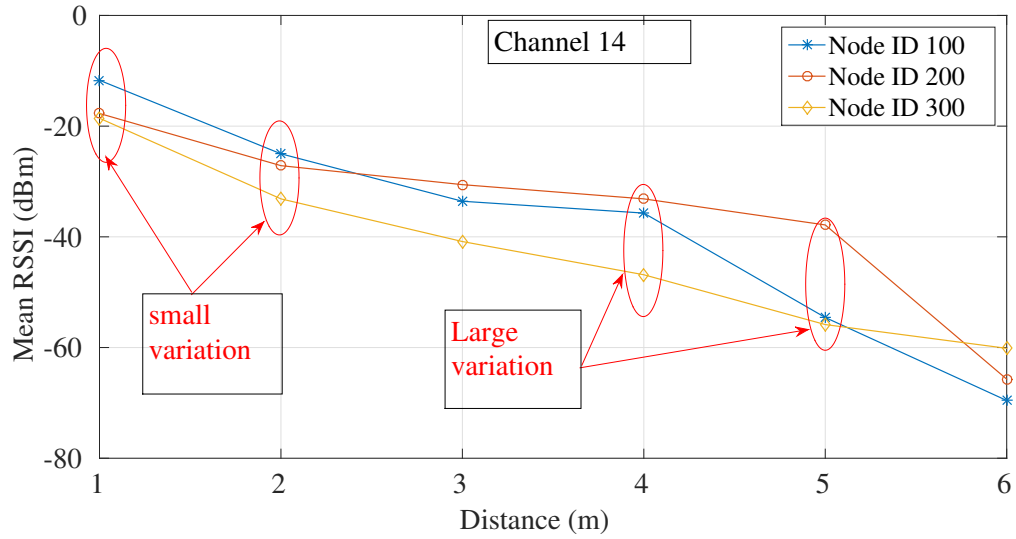


**Figure 3.3:** RSSI measurement at Node ID 200 with various channels

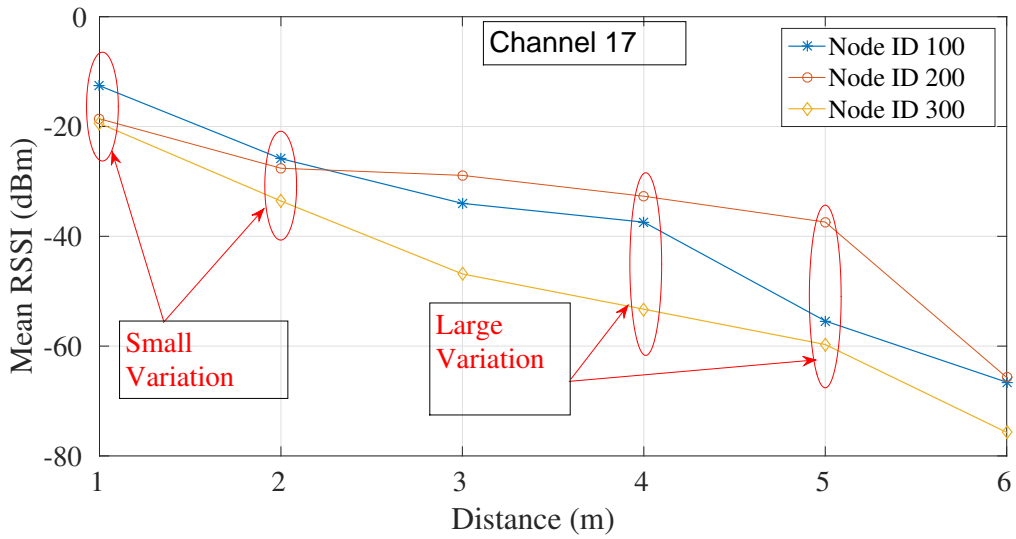


**Figure 3.4:** RSSI measurement at Node ID 300 with various channels

In the Figure .3.5, Figure .3.6, Figure .3.7, Figure .3.8, Figure .3.9, three different sensor nodes were used for same channel to receive RSS.



**Figure 3.5:** RSSI measurement at channel 14 with various nodes



**Figure 3.6:** RSSI measurement at channel 17 with various nodes

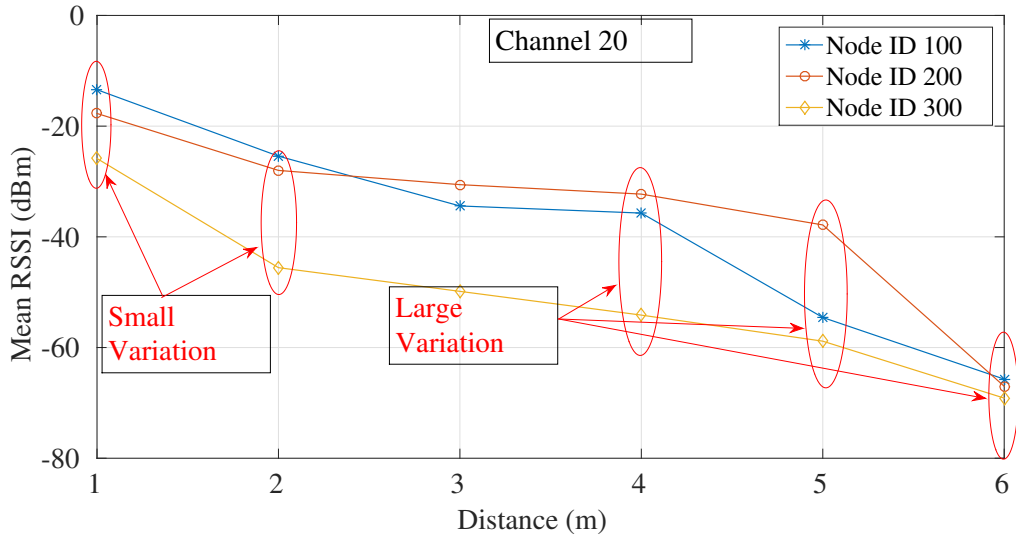


Figure 3.7: RSSI measurement at channel 20 with various nodes

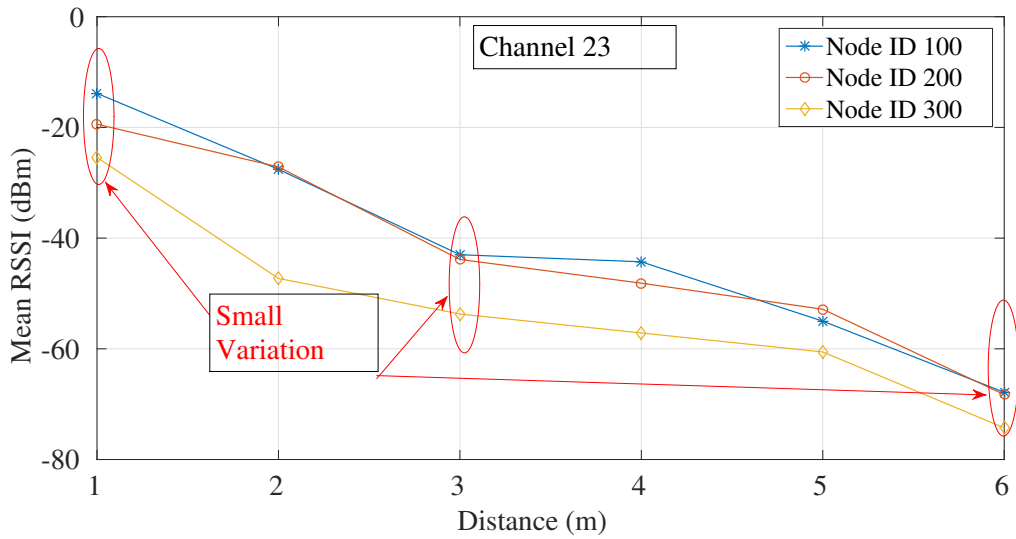
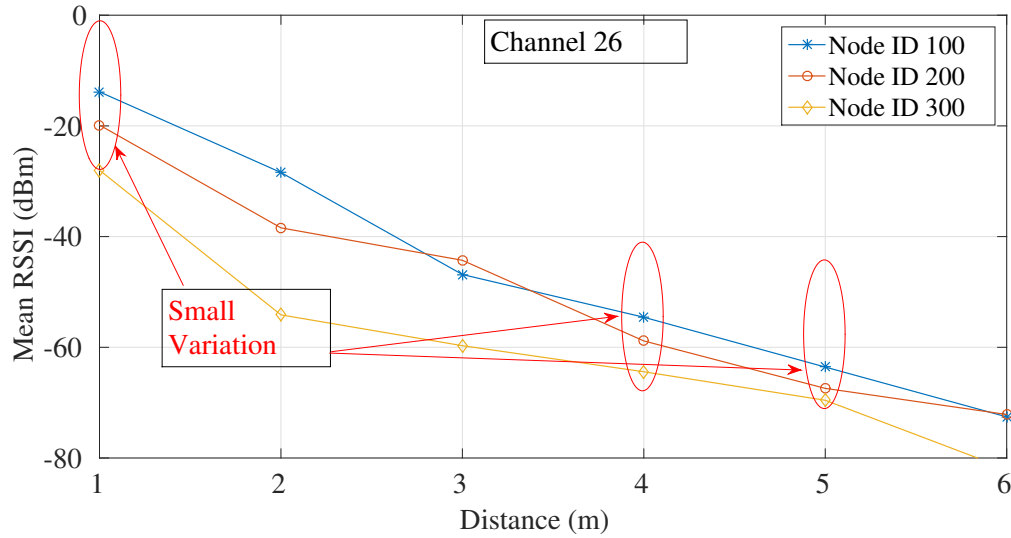


Figure 3.8: RSSI measurement at channel 23 with various nodes



**Figure 3.9:** RSSI measurement at channel 26 with various nodes

Here use of different frequency channels in same sensor node has shown more similar behavior within 3m of distance from the base station and slightly more deviation after that. Reason being multipath fading has less influence at the shorter distance.

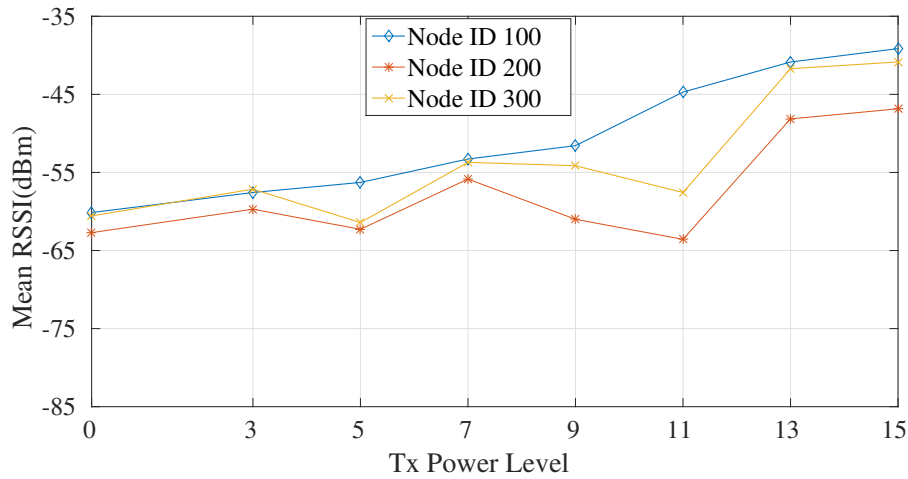
### 3.2.2.2 Transmitter Power level

Here we intend to verify the fluctuations introduced due to the several sensors at different power levels. For this purpose we have deployed 4 sensors (One BS and other communicating nodes) as shown in the Fig. 3.1. Received values of the RSSI from 3 different nodes were recorded in the time interval of 5 minutes till 30 minutes. Then mean of the RSSI is calculated. Fig. 3.10 shows the variation of mean RSSI to the different power levels. Range of received power for different nodes is shown in the following Table 3.2:

**Table 3.1:** Maximum and minimum value of mean RSSI for different nodes

Node ID	Maximum mean RSSI in dBm	Minimum RSSI in dBm
100	-39.14	-60.14
200	-46.85	-63.57
300	-40.85	-61.42

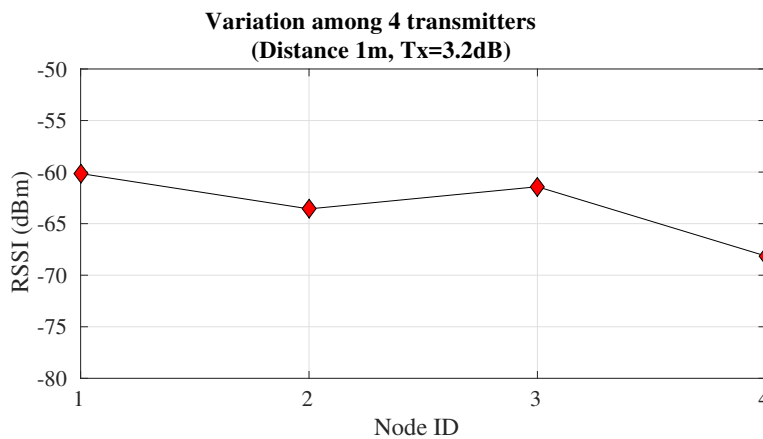
From Fig. 3.10, it can be inferred that :



**Figure 3.10:** Fluctuation in RSSI due to different power level

- With same transmitting power, Mean RSSI values for same type of receiver nodes were different.
- Variation between the nodes at the same position was small (approx.), except some points even if we have increased the transmitting power. We found that mean RSSI value from the node id 100 was always the highest except one mean measurement.

For our experiments, we have chosen 0 power level i.e. 3.2 dB for all the sensor nodes Figure .3.11.

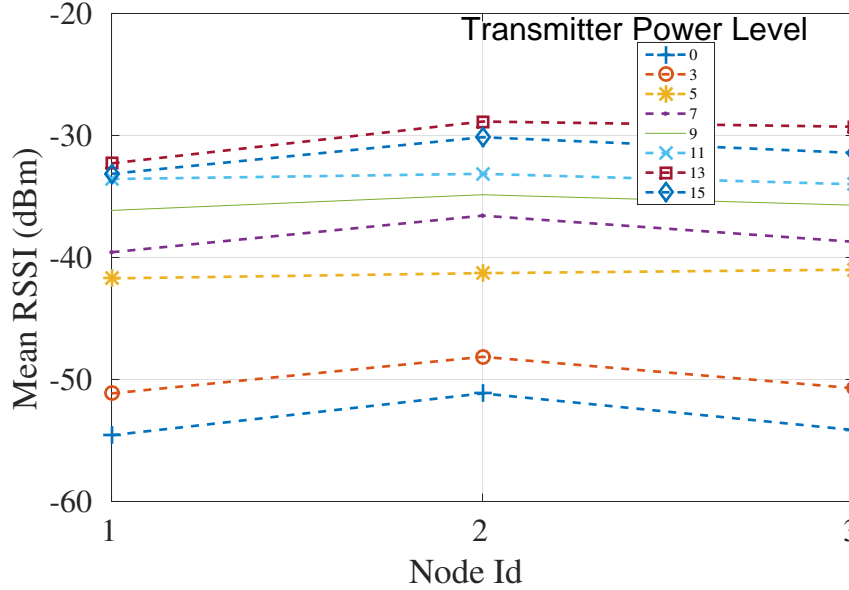


**Figure 3.11:** Fluctuation in RSSI due to same power level at different nodes



### 3.2.2.3 Fluctuation due to different sensors

The fluctuation in RSSI due to different power level is shown in Fig. 3.12.



**Figure 3.12:** RSSI fluctuation due to different power level in different sensor nodes

Here we intend to quantify the error introduced due to the non ideal sensors at different power levels. For this purpose we have deployed 4 sensors (One BS and other communicating nodes). Received values of the RSSI from 3 different nodes are recorded in the time interval of 5 minutes till 30 minutes. Then mean of the RSSI is calculated. Fig. 3.12 shows the variation of mean RSSI to the different power levels. For this experiment range of received power is shown in Tab. 3.2: From the above

**Table 3.2:** Maximum and minimum value of mean RSSI for this experiment

Node ID	Maximum mean RSSI in dBm	Minimum RSSI in dBm
1	-33.14	-54.57
2	-30.14	-51.14
3	-31.42	-54.14

results, it can be inferred that sensors do possess a strong variation in the readings although the readings were taken in the same place, at same external power level conditions.

#### **3.2.2.4 Results**

From the above experiment it is found that :

- With same transmitting power, RSSI values for different nodes were different.
- Variation between the nodes at the same position was small (approx.) except some points even if we have increased the transmitting power. We found that mean RSSI value from the node id 2 was always the highest except one mean measurement.

#### **3.2.2.5 Height of the transceiver**

##### **Experimental setup**

- Sensor Nodes used for the experiments were ZigBee ready modules which were programmed, connected to two AA batteries and were placed in the area of interest. Base station was communicating with the server via Universal Serial Cable (USB). Sensor modules have an Atmega1281 micro-controller which was programmed for required application. Also it uses the Atmel RF230 , IEEE 802.15.4 compliant, ZigBee ready radio frequency transceiver. Its operating frequency was within the range 2.405-2.48 GHz with 16 channels separated by 5 MHz frequency. Its minimum RSSI sensitivity is -91 dBm.

#### **3.2.3 Basic setup for the experiment.**

- Homogeneous sensors were selected for the purpose.
- Position of the base station and the sensors were stationary while recording the RSSI readings.
- Antenna of all the sensor nodes were pointed vertically upwards.
- For experimental work, we have placed sensor nodes in different indoor environment.
- No of sensor nodes were set to be 4 i.e. one BS and other three communicating nodes for some experiments.

- Tripod stands and card board packs were used to place the sensors at exactly at the required height above the ground.
  - Different heights from the ground were chosen within the range of 0.10m to 1.33m with a step of 0.20m.
  - Base Station received the RSSI from the communicating nodes.
  - Sensor nodes were static for the experiments.
  - Distance range was from 0 to 6m.
  - Several frequency channels as well as power levels were used for the experiments.
- In these conducted experiments, parameters that are defined for the Base station and other sensor nodes are enlisted in Table. 3.3.

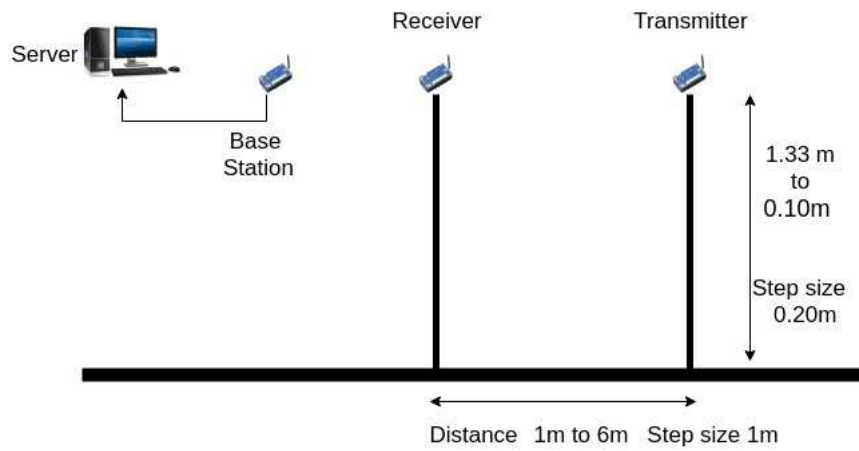
**Table 3.3:** Base Station and sensor nodes parameters

Parameter	Values
Power Transmitted	3.2 dB
Channel no Used for Transmission	26
Modulation technique	OQPSK
Frequency of Operation	2.48 GHz
Spreading technique	DSSS
Spreading Gain	9 dB
Data Rate	250 kbps
Antenna Length	1.2 inch
Antenna Gain	omnidirectional 3 dBi

To carry out our experiment, we have used both hardware ( Core i7 Intel 4790 CPU 3.60GHz processor, 64 bit for server, Intel(R) Core(TM) i5 CPU M540 @2.53 GHz 2.92 GB RAM laptop, IRIS motes) and software platform (Moteview, Matlab R2015a).

We have used two nos of XM2110 IRIS (product of MEMSIC sensor nodes (one BS and other one communicating nodes) to conduct the experiments as shown in Fig. 3.13.

The actual placement of nodes in real time indoor environment is shown in Fig. 3.14 - 3.16.



**Figure 3.13:** RSSI fluctuation at 0.10m to 1.33m



**Figure 3.14:** RSSI fluctuation at height 0.10m



**Figure 3.15:** RSSI fluctuation at height 0.241m



**Figure 3.16:** RSSI fluctuation at height 0.338m



**Figure 3.17:** RSSI fluctuation at height 0.5334m to 1.33m using tripod

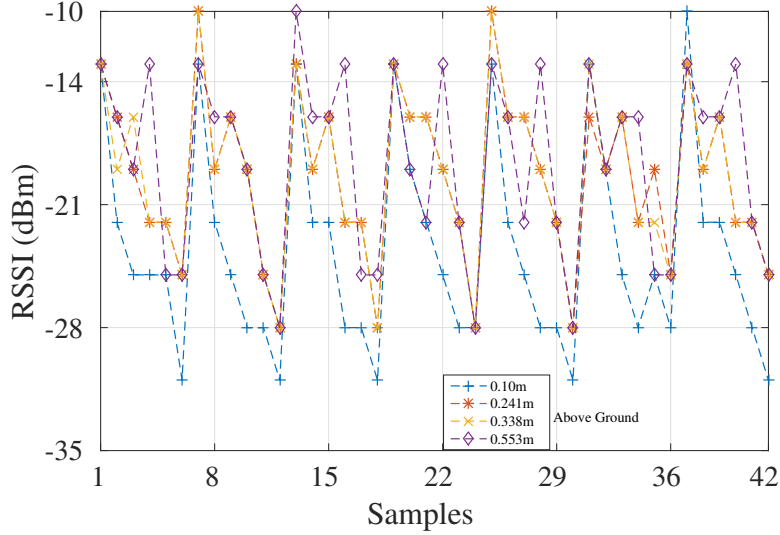
Figure 3.17 shows the node placement on the tripod with varying height from 0.5334m to 1.33m with 0.20m increasing step.

We have placed one of the sensor node to act as Base Station (BS) which was mounted on a MIB520 Interface Board and it has been connected to a server (Intel(R) Core(TM) i5 CPU M540 @2.53 GHz 2.92 GB RAM laptop) via USB port. The coordinating node or BS was programmed to perform as receiver. We have programmed all other nodes to transmit and the BS to receive the RSSI.

**Sample Collection and comparison** To carry out this experiment, a total of 7 samples were collected at each position at 6 different distances from 1m to 6 m with a step of 1m increase in distance. As we have placed 3 communicating nodes, therefore 126 samples (42 samples per node) were collected to analyze the variation in RSSI.

Fig. 3.18 shows the measured RSSI values for different height is plotted with

respect to the recorded number of samples in indoor environment.



**Figure 3.18:** Measured RSS values (different heights vs no of samples recorded)

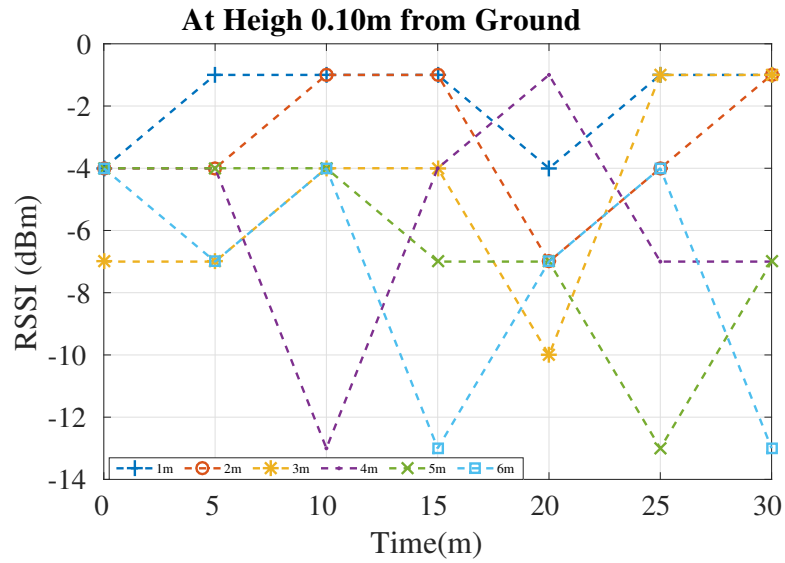
### 3.2.3.1 Variation in RSSI at different height above ground

- **At 0.10m height above ground:** Sensors were placed as shown in Fig. 3.14. Seven stable samples were recorded as shown in Table 3.4.

**Table 3.4:** Fluctuated RSSI Values at height 0.10m

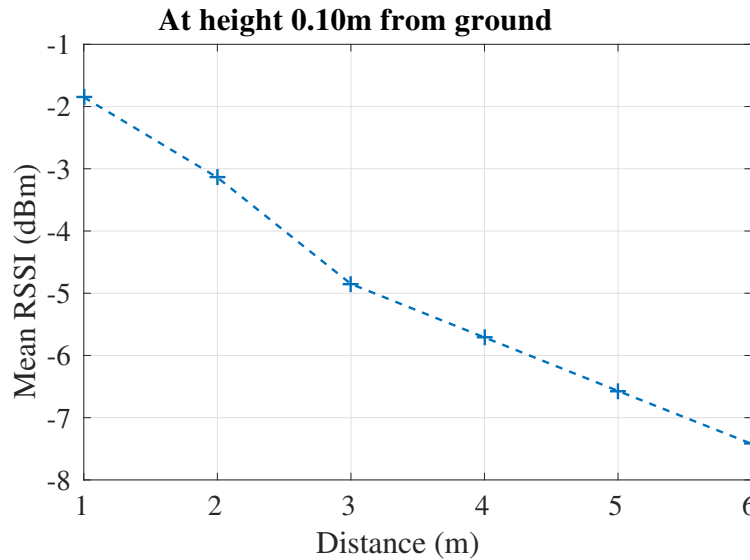
RSSI (dBm) / Distance(m)	1	2	3	4	5	6
RSSI <sub>1</sub>	-13	<b>-22</b>	<b>-25</b>	-25	-25	-31
RSSI <sub>2</sub>	-13	-22	-25	-28	-28	-31
RSSI <sub>3</sub>	<b>-13</b>	-22	-22	<b>-28</b>	-28	-31
RSSI <sub>4</sub>	-13	-19	-22	-25	-28	-28
RSSI <sub>5</sub>	-13	-22	-25	-28	-28	-31
RSSI <sub>6</sub>	-13	-19	-25	-28	-25	-28
RSSI <sub>7</sub>	-10	-22	-22	-25	-28	-31
Mean ( $\mu$ )	-12.57	-21.14	-23.71	-26.71	-27.57	-30.14

Fig. 3.19 shows the RSSI fluctuation at 0.10m above ground.



**Figure 3.19:** RSSI fluctuation at different time interval (0.10m above ground)

Fig. 3.20 shows the characteristics of RSSI vs Distance at 1m from the receiver.



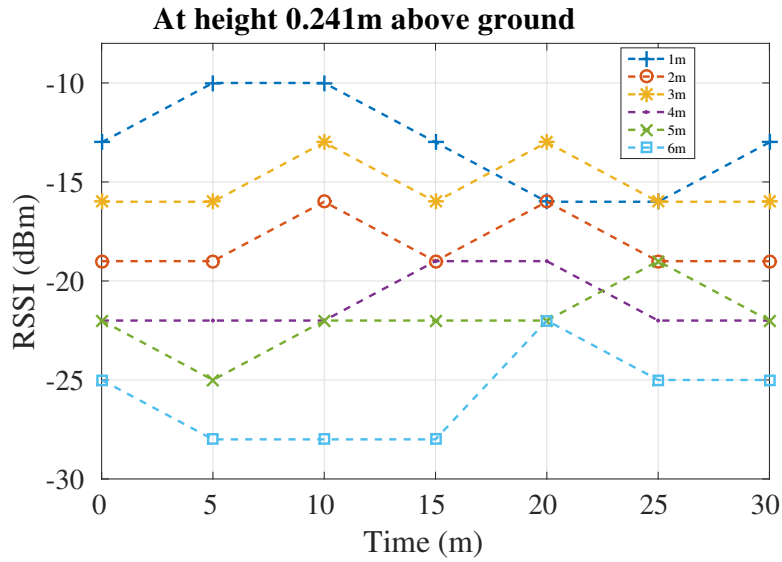
**Figure 3.20:** RSSI vs Distance characteristics at 1m with 0.10m above ground)

- **At 0.241m height above ground:** Sensors were placed as shown in Fig. 3.15. Seven stable samples were recorded as shown in Table 3.5.

**Table 3.5:** Fluctuated RSSI Values at height 0.241m

RSSI (dBm) / Distance(m)	1	2	3	4	5	6
RSSI <sub>1</sub>	-13	<b>-19</b>	<b>-16</b>	-22	-22	-25
RSSI <sub>2</sub>	-10	-19	-16	-22	-25	-28
RSSI <sub>3</sub>	<b>-10</b>	-16	-13	<b>-22</b>	-22	-28
RSSI <sub>4</sub>	-13	-19	-16	-19	-22	-28
RSSI <sub>5</sub>	-16	-16	-13	-19	-22	-22
RSSI <sub>6</sub>	-16	-19	-16	-22	-19	-25
RSSI <sub>7</sub>	-13	-19	-16	-22	-22	-25
Mean ( $\mu$ )	-13	-18.14	-15.14	-21.49	-22	-25.85

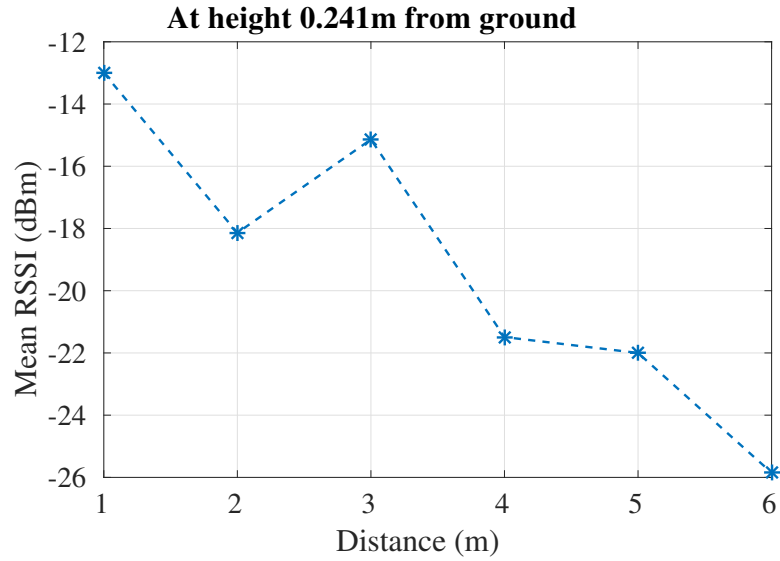
Fig. 3.21 shows the RSSI fluctuation at 0.241m above ground at a distance of 1m from the receiver.



**Figure 3.21:** RSSI fluctuation at different time interval (0.241m above ground)

Fig. 3.22 shows the characteristics of RSSI vs Distance at 1m from the receiver.





**Figure 3.22:** RSSI vs Distance characteristics at 1m with 0.241m above ground)

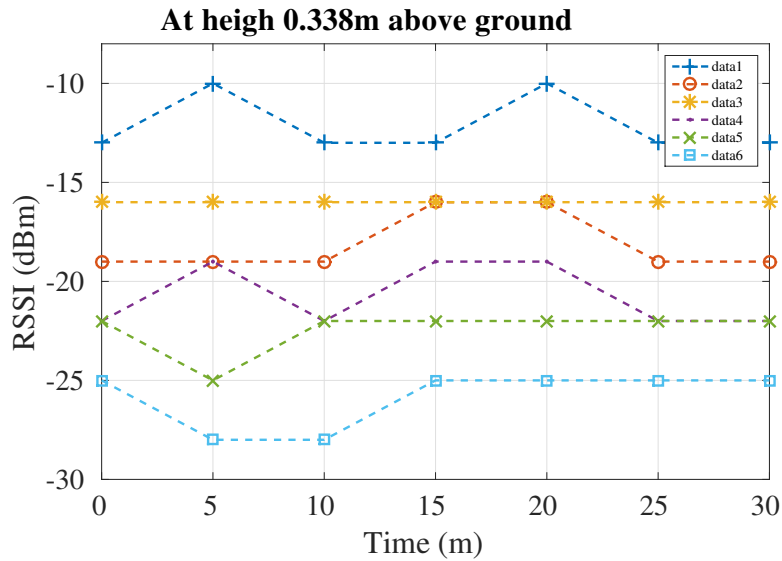
- **At 0.338m height above ground:** Sensors were placed as shown in Fig. 3.16. Seven stable samples were recorded as shown in Table 3.6.

**Table 3.6:** Fluctuated RSSI Values at height 0.338m

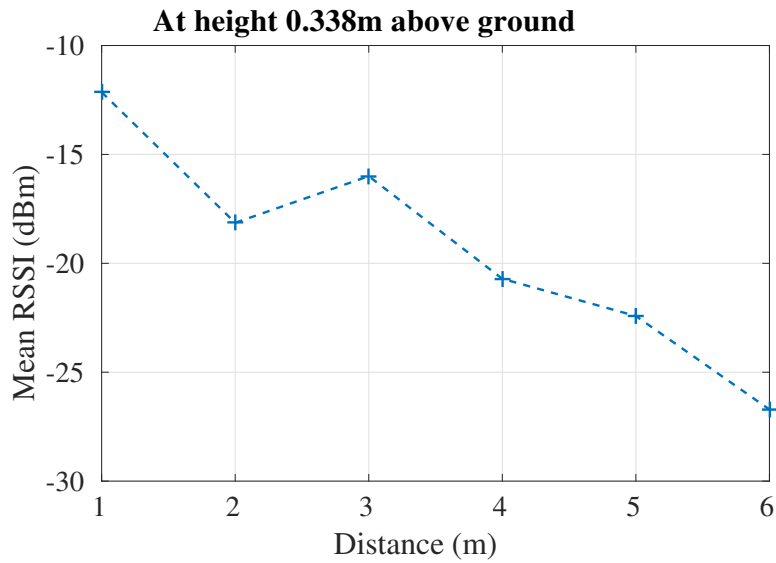
RSSI (dBm) / Distance(m)	1	2	3	4	5	6
RSSI <sub>1</sub>	-13	<b>-19</b>	<b>-16</b>	-22	-22	-25
RSSI <sub>2</sub>	-10	-19	-16	-19	-25	-28
RSSI <sub>3</sub>	<b>-13</b>	-19	-16	<b>-22</b>	-22	-28
RSSI <sub>4</sub>	-13	-16	-16	-19	-22	-28
RSSI <sub>5</sub>	-10	-16	-16	-19	-22	-28
RSSI <sub>6</sub>	-13	-19	-16	-22	-22	-25
RSSI <sub>7</sub>	-13	-19	-16	-22	-22	-25
Mean ( $\mu$ )	-12.14	-18.14	-16	-20.71	-22.42	-26.71

Fig. 3.23 shows the RSSI fluctuation at 0.338m above ground.

Fig. 3.24 shows the characteristics of RSSI vs Distance at 0.338m above ground.



**Figure 3.23:** RSSI fluctuation at different time interval (0.338m above ground)



**Figure 3.24:** RSSI vs Distance characteristics at 1m with 0.338m above ground)

• **At 0.533m height above ground:**

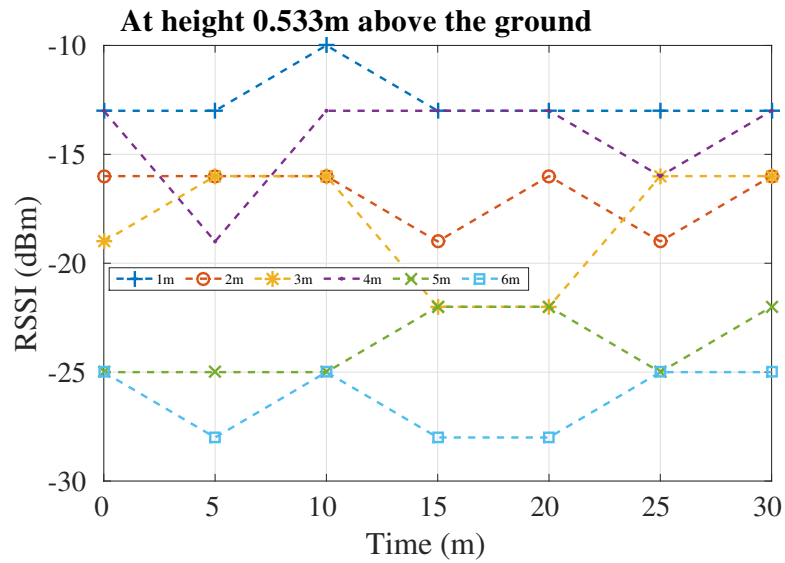
Sensors were placed as shown in Fig. 3.17. Seven stable samples were recorded as shown in Table 3.7.

Fig. 3.25 shows the RSSI fluctuation at 0.533m above ground.

Fig. 3.26 shows the characteristics of RSSI vs Distance at 0.533m above ground.

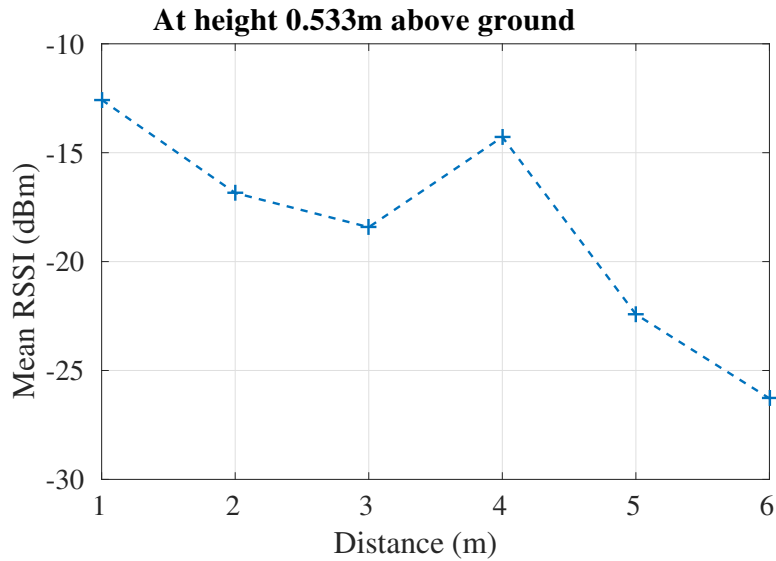
**Table 3.7:** Fluctuated RSSI Values at height 0.533m

RSSI (dBm) / Distance(m)	1	2	3	4	5	6
RSSI <sub>1</sub>	-13	<b>-16</b>	<b>-19</b>	-13	-25	-25
RSSI <sub>2</sub>	-13	-16	-16	-19	-25	-28
RSSI <sub>3</sub>	<b>-10</b>	-16	-16	<b>-13</b>	-25	-25
RSSI <sub>4</sub>	-13	-19	-22	-13	-22	-28
RSSI <sub>5</sub>	-13	-16	-22	-13	-22	-28
RSSI <sub>6</sub>	-13	-19	-16	-16	-25	-25
RSSI <sub>7</sub>	-13	-16	-16	-13	-22	-25
Mean ( $\mu$ )	-12.57	-16.85	-18.42	-14.28	-23.71	-26.28

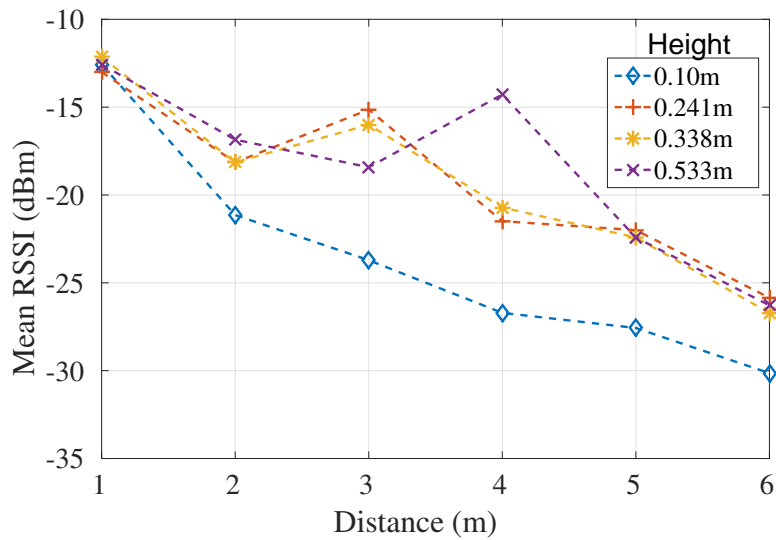


**Figure 3.25:** RSSI fluctuation at different time interval (0.533m above ground)

Comparison of the result based on the heights is represented in the Figure .3.27.



**Figure 3.26:** RSSI vs Distance characteristics at 1m with 0.533m above ground)

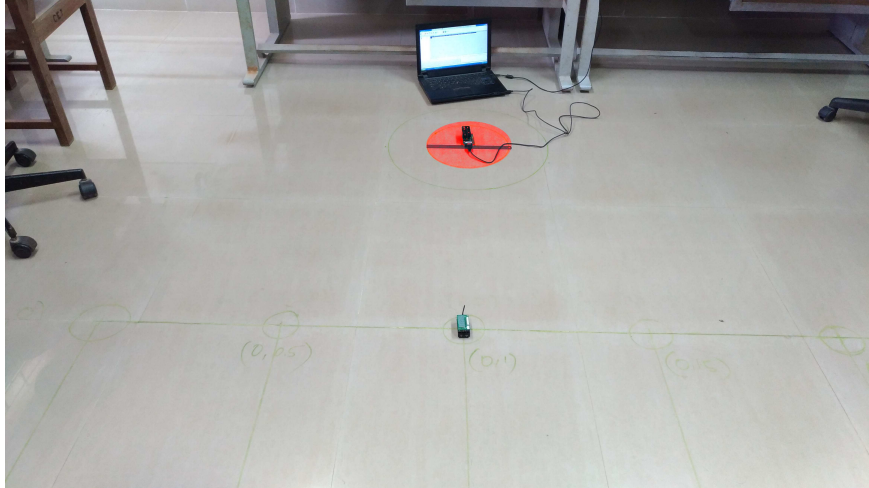


**Figure 3.27:** Comparison

### 3.2.3.2 Variation due to the Receiver movement (fixed $T_x$ ):

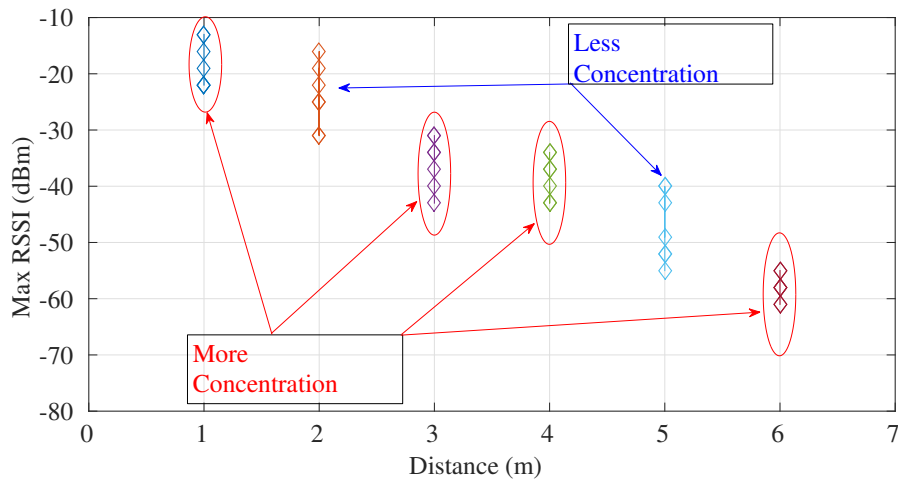
In this experiment, we have selected the channel 26 and wavelength of the radio used was calculated to be 4.9212598 inch which is 12.49 cms as the length of the antenna used was 1.2 inch (approx). In the above experiments as discussed earlier, receiver was fixed and measurements were recorded. Here we have moved the receiver to a maximum range of circle with the diameter of 12.49 cms as shown in Fig. 3.28 and

Fig. 3.29.



**Figure 3.28:** Mobility of the receiver with fixed sensor node at different distances

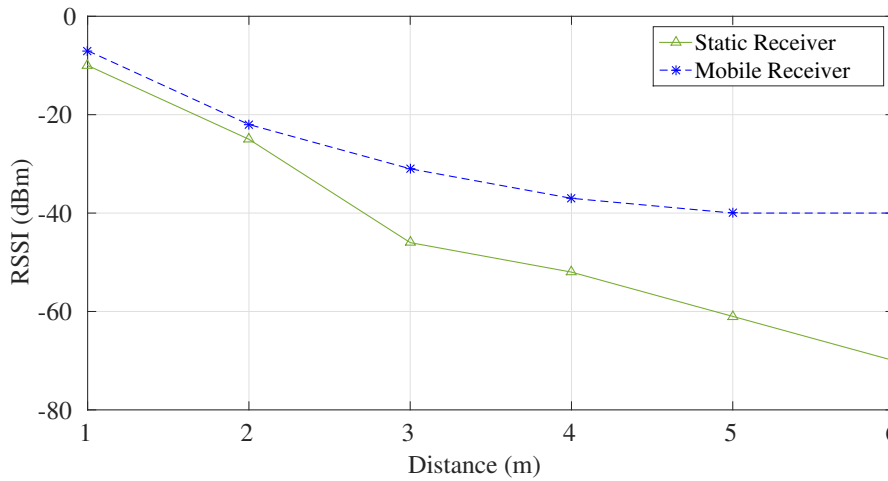
### 3.2.3.3 Results:



**Figure 3.29:** Maximum RSSI with mobile receiver

Here maximum RSSI of the mobile receiver are recorded at each distance to compare with the maximum RSSI recorded for the static receiver. From the Fig. 3.30, it can be inferred that, the RSSI graph shows a log normal distribution as:

- Difference in RSSI values of the node at 1 m and at 2 m is about 15 dBm.



**Figure 3.30:** RSSI-Distance relationship among static and mobile receiver

- Difference in RSSI values of the node at 2 m and at 3 m is about 9 dBm.
- Difference in RSSI values of the node at 4 m and at 5 m is about 3 dBm.
- Difference in RSSI values of the node at 5 m and at 6 m is about 0 dBm.

which follows the log normal signal model though it is difficult to move the receiver in practical scenarios.

### 3.2.3.4 Conclusion:

The conclusion drawn from the above experiment is :

- As the height of the  $T_x$  and  $R_x$  increases, ground reflection of the signal occurs and interaction takes place between the direct signal and reflected signal which results in dip in the RSSI vs Distance curve.
- The dip in RSS increases with the increase in the height from the ground.
- It was observed that the RSS values changed while changing the frequency values in the 2.4 GHz band (inspite of distance from the transmitter, transmitter power and height of the sensors from the ground were kept constant).
- Though the conditions during the particular experiments were kept unchanged, still fluctuation in measured RSS were noticed.

- As the characteristics for RSS with distance were almost following a common law, we can select the most stable RSS values for distance estimation as well as localization.
- Due to the different objects present near the vicinity of the experimental area, several factors like reflection, diffraction as well as scattering etc were affecting the RSS.

## Chapter 4

# RF signal propagation and RSSI model.

In chapter 4, RF signal propagation is studied and based upon this study, RSSI modeling is outlined. This model helps to validate our experimental work for distance estimation and further localization by incorporating 2.4 GHz Atmel ATmega1281 micro-controller. This model has taken into account of important constraints such as RSS influencing factors etc.



## 4.1 Introduction

RF signal strength level is predicted by the use of RF propagation method and RSS modeling at a particular distance with the signal variation. RF attenuation is predicted which reaches the receiver. Wireless sensor network constraints are considered that includes path loss exponent and standard deviation into account. These are validated in real indoor environment.

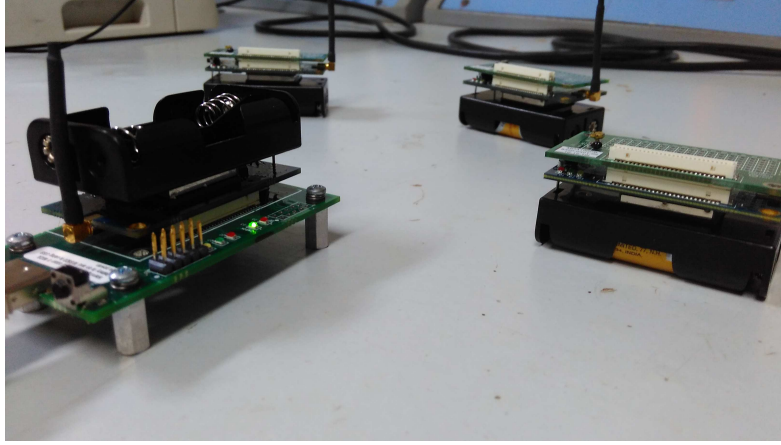
Some of the constraints are due to the presence of environmental noise, the recorded RSSI were quite fluctuating over time. Hence we have taken 12 samples of RSSI at the same place in different time span from 0 to 30 minutes.

- **Omnidirectionality of the sensor antenna:** Networking in wireless sensor network requires sensor node communication in all the direction. Hence omnidirectional antenna is appropriate for our experiment.
- **Low antenna height:** In wireless sensor network, sensing the object and finding the location of the sensor node is mostly close to the ground plane. Hence using sensor nodes above 1 to 3 meter from the ground is mostly not practical.
- **Battery operation:** To have the sensor network operational, we need to keep the battery discharge life as long as possible which requires most careful planning as energy consumption of battery is fast. Hence we need to take care of when the radio will be in idle mode or in ON mode.
- **Low power radio:** Radio in the sensor module consumes most of the power like 10 times than micro controller unit. Hence the necessity of the low power radio and sensor nodes should be within the range of the other sensor nodes.

### 4.1.1 Testbed:

For our experiment, we have used five IRIS (Crossbow) sensor nodes (one as BS and others as sensor nodes). Effect of antenna orientation of the wireless sensor nodes were considered. In the experiment, we have kept the antenna of the sensor node in vertically upward direction. The Fig. 4.1 and Fig. 4.2 shows one of the scenario for sensor node deployment in research lab.

IRIS mote uses the Atmel's AT86RF230 transceiver that receives the radio signal, whose strength is measured as RSSI. To map RSSI to distance, calibration is required.



**Figure 4.1:** Sensor node and Base Station for experiment



**Figure 4.2:** Placement of sensor node

The register which contains the RSSI level is a 8-bit register. RSSI level is only a 5 bit value which is shown in Figure .4.3. We have used IRIS mote for our work. Each LSB transition equals a 3 dB power level change. The range is limited from 0 to 28 level. The range reported by the RF230 chipset is -91dBm to -10dBm. RSSI is calculated as:

$$P_{RF} = RSSI_{BASEVALUE} + (3 \times (RSSI_{RAWVALUE} - 1)) \quad (4.1)$$

Addr	Name	Bit 7	Bit 6	Bit 5	Bit 4	Bit 3	Bit 2	Bit 1	Bit 0
0x06	PHY_RSSI	RX_CRC_VALID	RESERVED		RSSI				

**Figure 4.3:** Register containing RSSI value

Where  $P_{RF} \rightarrow$  RSSI (in dBm),  $RSSI_{BASEVALUE} \rightarrow$  RSSI Sensitivity and  $RSSI_{RAWVALUE} \rightarrow$  Measured signal strength (raw count) from sensor node.

#### 4.1.2 RSSI model:

After analyzing several alternatives for distance estimation, it is proposed that distance estimation of sensor nodes based on RSSI [Bergamo and Mazzini (2002)-Patwari *et al.* (2003)], will be appropriate as all other approaches (ToA, TDoA, AoA) may increase the power consumption, computational cost, complexity, use of extra hardware, synchronization etc. In the distance estimation based on RSSI, the signal strength received from each sensor node is measured. With the help of these measured received signal strength, the distance is estimated which is generally based on the Inverse Square Law [Krishnamachari (2005)-Rappaport et al. (1996)]. Electromagnetic waves generally obey Inverse Square Law in free space which depicts that:

Power density  $\propto$  inverse of square of the distance from the source [Hashemi (1993), Durgin (2003)].

The received radio signal degrades its strength as the inverse square of distance 'd' traveled between two sensors. Friis equation [Rappaport et al. (1996), Visser (2006)] depicts the relation between received power  $P_r$  to the distance d which is given by:

$$\frac{P_r(d)}{P_t} = G_t G_r \left( \frac{\lambda}{4\pi} \right)^2 \left( \frac{1}{d^2} \right) \quad (4.2)$$

where  $P_t$  = Transmitted power,  $G_t$  = Gain of the Transmitting Antenna,  $G_r$  = Gain of the Receiving Antenna and  $\lambda$  = Wavelength.

As

$$P \propto \frac{1}{d^n} \quad (4.3)$$

$$RSSI \propto 10 \times \log\left(\frac{1}{d}\right)^n \quad (4.4)$$

$$\Rightarrow RSSI = -10 \times n \times \log(d) + S \quad (4.5)$$

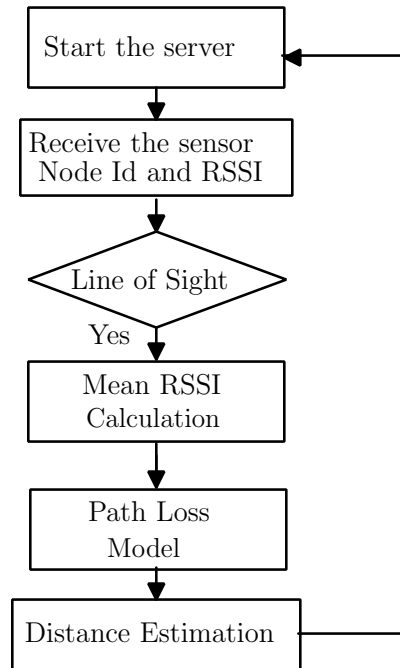
$$\Rightarrow RSSI = -m \times D + S \quad (4.6)$$

Where  $D = \log(d)$ ,  $m = 10 \times n$ ,  $S = \text{constant}$ .

In real scenarios, propagated radio signal is usually affected by environment, effects such as reflection, diffraction and scattering. The empirical evidence has shown that RSSI can be modeled at any value of  $d$  for a particular location and log normally distributed random variable with mean value which is mostly distance dependent.

Here selected area for experiment was chosen to be of 6m length and 2m width. XM2110 is used for transmitter as well as for receiver. XM2110 sensor node with sensor board MDA100 and gateway MIB520 formed a base station (BS). Series of experiments were conducted to analyze the variation in RSS values at different distance from base station.

Average of all the RSS values were plotted for analysis. MATLAB 2015 was used to plot the response of the result. The flow chart for the this work is shown in Figure .4.4.



**Figure 4.4:** Work Flow

**Table 4.1:** Measured data of the conducted experiment

Distance (m)	RSSI (dBm)	Distance (m)	RSSI (dBm)
0.25	-19	3.25	-49
0.5	-22	3.5	-49
0.75	-28	3.75	-52
1	-31	4	-55
1.25	-31	4.25	-55
1.5	-34	4.5	-58
1.75	-34	4.75	-64
2	-40	5	-70
2.25	-43	5.25	-76
2.5	-46	5.5	-76
2.75	-46	5.75	-82
3	-49	6	-82

#### 4.1.2.1 Calculation of Path Loss Exponent (PLE) :

Distribution of Path Loss ( $PL(d)$ ) is Log-normal about the mean distance [(Rappaport et al., 1996), (Rappaport *et al.*, 1996)]. This is also random in nature for a particular location. Path loss is affected by several factors such as reflection, diffraction of the interfering object over the path in which the radio frequency signal travels. Mathematical equation related to this phenomenon is given as:

$$PL(d)_{[dB]} = PL(d_0) + 10n \log\left(\frac{d}{d_0}\right) + X_\sigma \quad (4.7)$$

where  $X_\sigma$  is the zero-mean Gaussian distributed random variable in dB with standard deviation  $\sigma$  and  $n$  is the path loss exponent.

$n$  and  $\sigma$  are calculated by the minimization of the MSE of measured and estimated path loss, from the received data as shown in Table .4.1. The power received at a distance  $d$  from transmitter is calculated as:

$$P_r(d) = P_r(d_0) - 10n \log\left(\frac{d}{d_0}\right) + X_\sigma \quad (4.8)$$

MMSE is calculated as per the formula given as:

$$J(n) = \sum_{i=1}^k ((P_{r_{\text{computed}}}) - (P_{r_{\text{estimated}}}))^2 \quad (4.9)$$

#### 4.1.2.2 Results and analysis:

Power received at different distances in 24 steps with the interval of 0.25 (m), are calculated as per the data obtained 4.1.

$$P_r(d_1) = -10 - 10\log\left(\frac{0.25}{0.25}\right) = -10 \quad (4.10)$$

$$P_r(d_2) = -10 - 10\log\left(\frac{0.5}{0.25}\right) = -10 - 3.010n \quad (4.11)$$

$$P_r(d_3) = -10 - 10\log\left(\frac{0.75}{0.25}\right) = -10 - 4.771n \quad (4.12)$$

$$P_r(d_4) = -10 - 10\log\left(\frac{1}{0.25}\right) = -10 - 6.020n \quad (4.13)$$

$$P_r(d_5) = -10 - 10\log\left(\frac{1.25}{0.25}\right) = -10 - 6.989n \quad (4.14)$$

$$P_r(d_6) = -10 - 10\log\left(\frac{1.5}{0.25}\right) = -10 - 7.781n \quad (4.15)$$

$$P_r(d_7) = -10 - 10\log\left(\frac{1.75}{0.25}\right) = -10 - 8.45n \quad (4.16)$$

$$P_r(d_8) = -10 - 10\log\left(\frac{2}{0.25}\right) = -10 - 9.030n \quad (4.17)$$

$$P_r(d_9) = -10 - 10\log\left(\frac{2.25}{0.25}\right) = -10 - 9.542n \quad (4.18)$$

$$P_r(d_{10}) = -10 - 10\log\left(\frac{2.5}{0.25}\right) = -10 - 10n \quad (4.19)$$

$$P_r(d_{11}) = -10 - 10\log\left(\frac{2.75}{0.25}\right) = -10 - 10.413n \quad (4.20)$$

$$P_r(d_{12}) = -10 - 10\log\left(\frac{3}{0.25}\right) = -10 - 10.791n \quad (4.21)$$

$$P_r(d_{13}) = -10 - 10\log\left(\frac{3.25}{0.25}\right) = -10 - 11.139n \quad (4.22)$$

$$P_r(d_{14}) = -10 - 10\log\left(\frac{3.5}{0.25}\right) = -10 - 11.461n \quad (4.23)$$

$$P_r(d_{15}) = -10 - 10\log\left(\frac{3.75}{0.25}\right) = -10 - 11.760n \quad (4.24)$$

$$P_r(d_{16}) = -10 - 10\log\left(\frac{4}{0.25}\right) = -10 - 12.041n \quad (4.25)$$

$$P_r(d_{17}) = -10 - 10\log\left(\frac{4.25}{0.25}\right) = -10 - 12.304n \quad (4.26)$$

$$P_r(d_{18}) = -10 - 10\log\left(\frac{4.5}{0.25}\right) = -10 - 12.552n \quad (4.27)$$

$$P_r(d_{19}) = -10 - 10\log\left(\frac{4.75}{0.25}\right) = -10 - 12.787n \quad (4.28)$$

$$P_r(d_{20}) = -10 - 10\log\left(\frac{5}{0.25}\right) = -10 - 13.010n \quad (4.29)$$

$$P_r(d_{21}) = -10 - 10\log\left(\frac{5.25}{0.25}\right) = -10 - 13.222n \quad (4.30)$$

$$P_r(d_{22}) = -10 - 10\log\left(\frac{5.5}{0.25}\right) = -10 - 13.424n \quad (4.31)$$

$$P_r(d_{23}) = -10 - 10\log\left(\frac{5.75}{0.25}\right) = -10 - 13.617n \quad (4.32)$$

$$P_r(d_{24}) = -10 - 10\log\left(\frac{6}{0.25}\right) = -10 - 13.802n \quad (4.33)$$

Here MMSE is the squared errors between measured and estimated values which is given as:

$$\begin{aligned} J(n) = & [-19 - (-10)]^2 + [-22 - (-10 - 3.010n)]^2 + [-28 - (-10 - 4.771n)]^2 \\ & + [-31 - (-10 - 6.020n)]^2 + [-31 - (-10 - 6.989n)]^2 \\ & + [-34 - (-10 - 7.781n)]^2 + [-34 - (-10 - 8.45n)]^2 \\ & + [-40 - (-10 - 9.030n)]^2 + [-43 - (-10 - 9.542n)]^2 \\ & + [-46 - (-10 - 10n)]^2 + [-46 - (-10 - 10.413n)]^2 \\ & + [-49 - (-10 - 10.791n)]^2 + [-49 - (-10 - 11.139n)]^2 \\ & + [-49 - (-10 - 11.461n)]^2 + [-52 - (-10 - 11.760n)]^2 \\ & + [-55 - (-10 - 12.041n)]^2 + [-55 - (-10 - 12.304n)]^2 \\ & + [-58 - (-10 - 12.55n)]^2 + [-64 - (-10 - 12.787n)]^2 \\ & + [-70 - (-10 - 13.010n)]^2 + [-76 - (-10 - 13.222n)]^2 \\ & + [-76 - (-10 - 13.424n)]^2 + [-82 - (-10 - 13.617n)]^2 \\ & + [-82 - (-10 - 13.802n)]^2 \end{aligned} \quad (4.34)$$

$$\Rightarrow J(n) = 2657.575n^2 - 21606.434n + 45441 \quad (4.35)$$

Now  $n$  can be obtained by taking derivative of the equation 4.35 which is:

$$5315.15n + 21606.434 = 0 \quad (4.36)$$

$$\Rightarrow n = 4.06 \quad (4.37)$$

So path loss exponent for this test experiment is found to be 4.06.

Calculation of sigma can be obtained from:

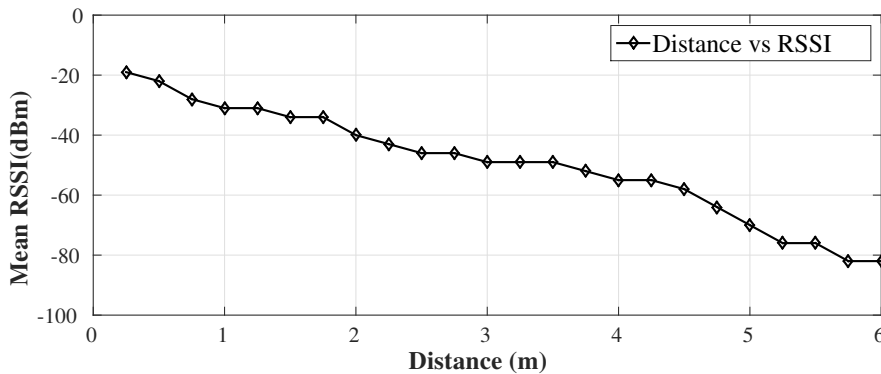
$$\sigma^2 = \frac{J(n)}{24} \quad (4.38)$$

at  $n = 4.06$  is given as  $\sigma^2 = \frac{J(4.06)}{24} = 63.55$

Hence  $\sigma$  is calculated as 7.97.

Here in this experiment  $n$  and  $\sigma$  was found to be within the acceptable range. The received RSS values were plotted against the respective distance for analysis.

The Figure .4.5 shows the plot of the relationship that exists between Distance and mean RSSI.



**Figure 4.5:** Distance-RSSI

From the above characteristic, it shows that RSS values decreases with increase in distance from the base station but not as expected to be. Hence we need to analyze the various factors that influences the RSS.



## Chapter 5

# RSS measurement and mitigation of abnormal RSS values.

In Chapter 5, RSS values were collected and recorded from the carried out experiments. These results includes the abnormal RSS values, which is the effect of several environmental factors. Here methods have been imposed to mitigate the abnormal RSS values with the help of gaussian and averaging filter.

## 5.1 Experiments and results

### 5.1.1 Experimental setup

The setup for the experimental work is as follows :

- Sensor nodes were deployed in several indoor environment.
- Maximum no. of sensor nodes were set to be 5.
- Sensor nodes were placed 1.22 m above the ground on tripod stand in some experiments.
- RSS was received by the Base Station.
- Deployed sensor nodes were static.

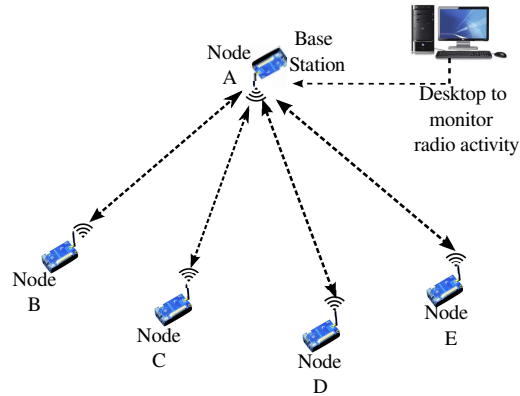
#### 5.1.1.1 Basic Assumptions for the experiment.

- The network area used for the experimental purpose is a fixed  $M \times N$  area with length  $M$  (6 ft) and width  $N$  (3 ft) and  $K$  (5) number of sensors.
- Homogeneous sensor nodes were used as they possess the same transmission range as well as the same initial energy.
- As we are using the static model, location of the anchor sensors and the base station remained unchanged.

#### 5.1.1.2 Software and Hardware setup

In this experimental work, we have used software platform Moteview for configuring IRIS motes and Matlab R2015a for computation. To carry out the experiment, we have used both hardware ( Core i7 Intel 4790 CPU 3.60GHz processor, 64 bit for server, IRIS motes) and software (Moteview and Matlab). The architecture used to carry out the analysis, involved five nos of XM2110 IRIS (product of MEMSIC [MEMSIC (2012)]) sensor nodes (one BS and other four communicating nodes) as shown in Fig. 5.1.

Base Station i.e node A was mounted on a MIB520 Interface Board and was connected to a PC ( Core i7 Intel 4790 CPU 3.60GHz processor, 64 bit) via USB



**Figure 5.1:** Wireless Sensor Network Setup

port. Base station was programmed with XMeshBase firmware to act as a receiver. All other nodes were programmed to transmit the packets. BS had to record all the RSSI data. RF power level was set to 3.2 dBm (level 0). Antenna connected to each sensor node is of 1.2 inch omni-directional with the gain of 3 dBi. Data transmission rate was 250 kbps. The frequency of operation was kept 2.4 GHz with IEEE 802.15.4 standard for communication.

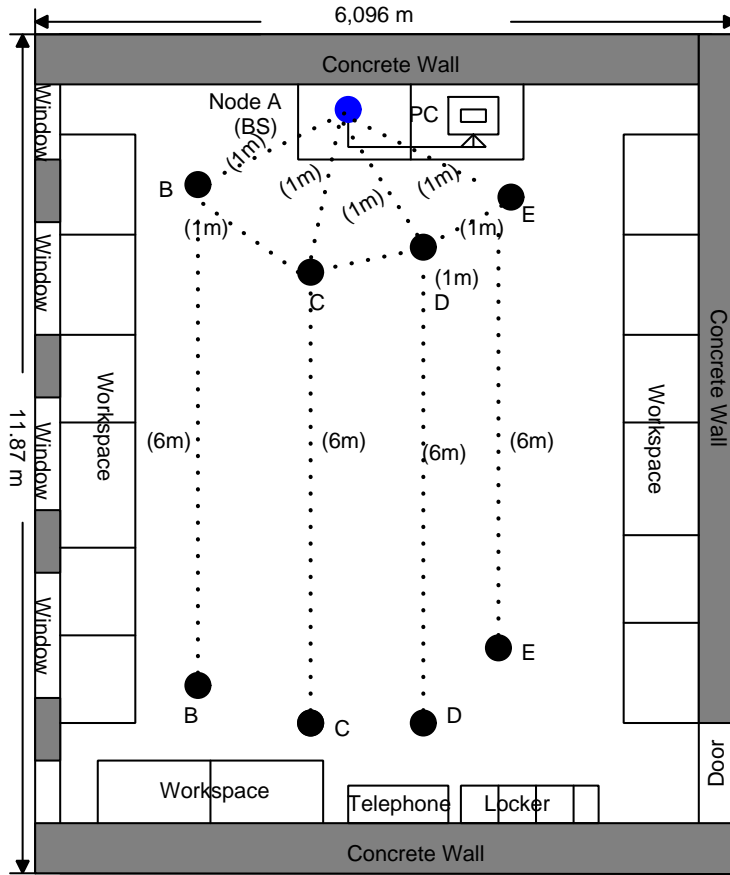
Here our first step was to analyze the RSSI data received through the experiment conducted.



**Figure 5.2:** Sensor Nodes installed on Tripods in Research Lab

With reference to the Fig. 5.3, Sensor Node A represents the Base Station (BS) and PC is the server. Sensor Node B, C, D, E represent the communicating nodes.

We have taken the measurement using the architecture as shown in Fig. 5.3 and implemented the sensors as shown in Fig. 5.2. Each sensor node was placed on tripod



**Figure 5.3:** Experimental Model (BS and Nodes in LOS) (Top-View)

stand for some experiments with a height of 1.2192 m.

### 5.1.1.3 Results and analysis:

RSSI values were recorded at difference distances 1m, 1.25m, 1.5m, 1.75m, 2m, 2.25m, 2.5m, 2.75m, 3m, 3.25m, 3.5m, 3.75m, 4m, 4.25m, 4.5m, 4.75m, 5m, 5.25m, 5.5m, 5.75m, 6m. Due to the presence of environmental noise, the recorded RSSI were quite fluctuating over time. Hence we have taken 12 samples of RSSI at the same place in different time span from 0 to 30 minutes.

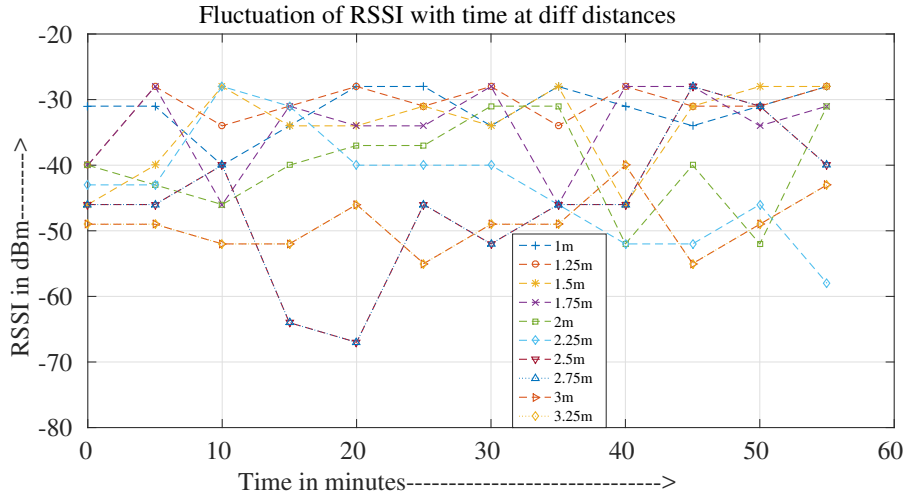
**Table 5.1:** Fluctuated RSSI Values at 1m to 3.25m

RSSI / Distance	1	1.25	1.5	1.75	2	2.25	2.5	2.75	3	3.25
RSSI <sub>1</sub>	-31	<b>-40</b>	<b>-46</b>	-40	-40	-43	-46	<b>-67</b>	-49	-52
RSSI <sub>2</sub>	-31	-28	-40	-28	-43	-43	-46	-46	-49	-52
RSSI <sub>3</sub>	<b>-40</b>	-34	-28	<b>-46</b>	-46	-28	-40	-46	-52	-49
RSSI <sub>4</sub>	-34	-31	-34	-31	-40	-31	-64	-40	-52	-49
RSSI <sub>5</sub>	-28	-28	-34	-34	-37	-40	<b>-67</b>	-64	-46	-46
RSSI <sub>6</sub>	-28	-31	-31	-34	-37	-40	-46	-46	-55	-49
RSSI <sub>7</sub>	-34	-28	-34	-28	-31	-40	-52	-46	-49	-49
RSSI <sub>8</sub>	-28	-34	-28	<b>-46</b>	-31	-46	-46	-52	-49	-55
RSSI <sub>9</sub>	-31	-28	<b>-46</b>	-28	-52	-52	-46	-46	<b>-40</b>	-43
RSSI <sub>10</sub>	-34	-31	-31	-28	-40	-52	-28	-28	-55	-40
RSSI <sub>11</sub>	-31	-31	-28	-34	-52	-46	-31	-40	-49	-55
RSSI <sub>12</sub>	-28	-28	-28	-31	-31	<b>-58</b>	-40	-31	-43	-49
$\mu$	-31.5	-31	-34	-34	-40	-43	-46	-46	-49	-49
$\gamma$	3.57	3.61	6.64	6.64	7.34	8.53	11.36	11.36	4.39	4.39
$\mu - \sqrt{3}\gamma$	-37.68	-37.25	-45.50	-45.50	-52.71	-57.77	-65.67	-65.67	-56.60	-56.60
$\mu + \sqrt{3}\gamma$	-25.31	-24.74	-22.5	-22.5	-27.28	-28.23	-26.33	-26.33	-41.39	-41.39

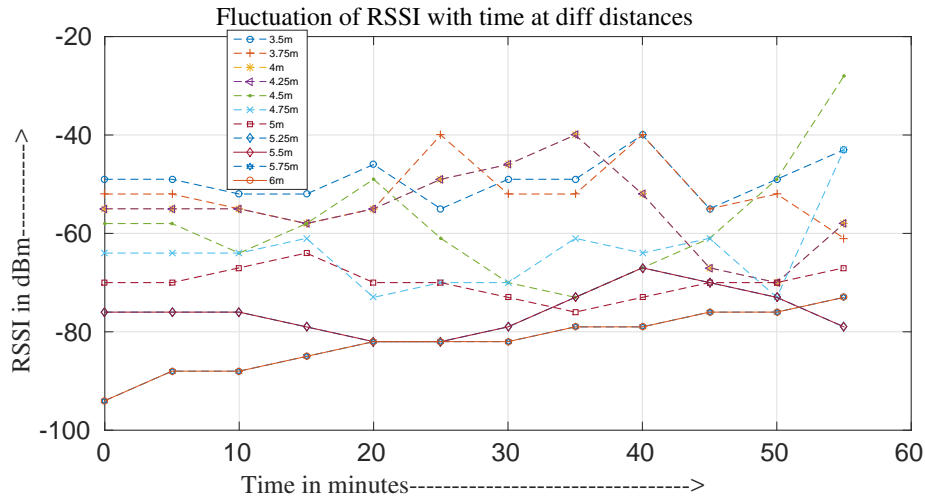
**Table 5.2:** Fluctuated RSSI Values at 3.5m to 6m

RSSI/Distance	3.5	3.75	4	4.25	4.5	4.75	5	5.25	5.5	5.75	6
RSSI <sub>1</sub>	-55	-52	-55	-58	-58	-64	-70	-76	-82	<b>-94</b>	-88
RSSI <sub>2</sub>	-55	-52	-55	-58	-58	-64	-70	-76	-82	-88	-88
RSSI <sub>3</sub>	-52	-55	-55	-55	-58	-64	-67	-76	-79	-88	-85
RSSI <sub>4</sub>	-52	-58	-58	-55	-61	-61	<b>-64</b>	-79	-79	-85	-85
RSSI <sub>5</sub>	-49	-55	-55	-55	-61	-73	-70	-82	-79	-82	<b>-94</b>
RSSI <sub>6</sub>	-49	<b>-40</b>	-49	<b>-40</b>	-64	-70	-70	-82	-76	-82	-82
RSSI <sub>7</sub>	-49	-52	-46	-46	-49	-70	-73	-79	-76	-82	-82
RSSI <sub>8</sub>	-43	-52	<b>-40</b>	-49	-49	-61	<b>-76</b>	-73	-76	-79	-76
RSSI <sub>9</sub>	-49	<b>-40</b>	-52	-52	-73	-64	-73	<b>-67</b>	-73	-79	-79
RSSI <sub>10</sub>	-46	-55	-67	-55	-70	-61	-70	-70	-73	-76	-79
RSSI <sub>11</sub>	-52	<b>-70</b>	-67	-67	-73	-70	-73	-70	-76	-76	-76
RSSI <sub>12</sub>	<b>-40</b>	-61	-58	<b>-70</b>	<b>-28</b>	<b>-43</b>	-67	-79	<b>-67</b>	-73	-73
$\mu$	-49	-52	-55	-55	-58	-64	-70	-76	-76	-82	-82
$\gamma$	4.39	6.20	8.19	8.19	10.84	7.98	3.13	4.61	4.61	6	6
$\mu - \sqrt{3}\gamma$	-56.60	-62.73	-69.18	-69.18	-76.77	-77.82	-75.42	-83.98	-83.98	-92.39	-92.39
$\mu + \sqrt{3}\gamma$	-41.4	-41.27	-40.81	-40.82	-39.23	-50.17	-64.58	-68.02	-68.02	-71.61	-71.61

From this measured value as shown in Table 5.1 and Table 5.2, we have found that some RSSI values were too large or too small as compared to other values.



**Figure 5.4:** Fluctuation of RSS at distance from 1m to 3.25m



**Figure 5.5:** Fluctuation of RSS at distance from 3.5m to 6m

Fluctuation of RSSI with time at different distances is shown in Fig. 5.4 and Fig. 5.5.

To eliminate the contained error in the experimental results, we have used Gaussian filter to mitigate all the abnormal RSSI values caused by the environmental factors. The PDF (Probability Density Function) of Gaussian distribution ( $\mu, \gamma^2$ ) is formulated

as

$$f(\text{RSSI}) = \frac{1}{\sqrt{2\pi\gamma}} e^{-(\text{RSSI}-\mu)^2/2\gamma^2} \quad (5.1)$$

where

$$\mu = \frac{1}{k} \sum_{i=1}^k \text{RSSI}_i \quad (5.2)$$

tends to be the mean of RSSI values in k no. of tests and

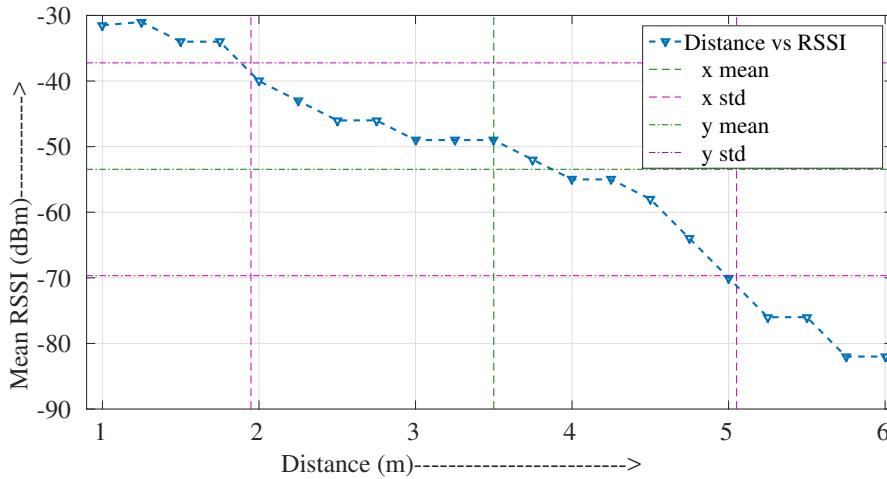
$$\gamma^2 = \frac{1}{k-1} \sum_{i=1}^k (\text{RSSI}_i - \mu)^2 \quad (5.3)$$

tends to be the variance.

We have set the filter range [Holtzman (1992), Holtzmann (1992)] as  $[\mu - \sqrt{3}\gamma, \mu + \sqrt{3}\gamma]$ . The measured RSSI values outside this specified range is ignored. Still the output of the Gaussian filter contains much variations in RSSI. Hence we need to apply the averaging filter to obtain the average RSSI values for the purpose of calculation. Equation used for estimation purpose is given as:

$$\text{RSSI}_{(avg)} = \frac{1}{m} \sum_{i=1}^m \text{RSSI}_i \quad (5.4)$$

The relationship of RSSI with increase in distance is represented in Fig. 5.6.



**Figure 5.6:** Distance vs Mean RSSI



**Shadowing Model Analysis:** As discussed above, RSSI indicated the received signal strength when the reference distance is  $d_0$  is and  $n$  indicated the path loss index. For this experiment 12 stable RSS data were continuously measured. Hence at 1m distance, we have the received the RSSI as -31 dBm (approx) value.

Path loss exponent  $n$  with increase in distance is satisfied with the relation given as:

$$RSSI = -10 - 10 * n * \log\left[\frac{1}{d_0}\right] \quad (5.5)$$

$$\Rightarrow n = \frac{10 + RSSI}{10 * \log\left[\frac{1}{d_0}\right]} \quad (5.6)$$

$$\Rightarrow J(n) = 2657.575n^2 - 21606.434n + 45360 \quad (5.7)$$

Now  $n$  can be obtained by taking derivative of the equation (5.7) which is:

$$5315.15n - 21606.434 = 0 \quad (5.8)$$

$$\Rightarrow n = 4.06 \quad (5.9)$$

So path loss exponent for this test experiment was found to be 4.06.

With the above obtained parameter, Shadowing model for our experiment is as follows:

$$P_r(d) = -31 - 10 * 4.06 * \log\left(\frac{d}{d_0}\right) + X_\gamma \quad (5.10)$$

$$RSSI_d = B - 10 * n * \log d_{e_i} \quad (5.11)$$

where  $X_\gamma$  is the Gaussian distributed random variable with zero mean in dB and with standard deviation  $\gamma$  ranging from 4 to 10.  $n$  is the path loss exponent. Hence fitting curve of Probability density of RSSI = -31 dBm is given as follows:

$$f(RSSI) = A * e^{-(RSSI-53.44)^2/2\gamma^2} \quad (5.12)$$

Where  $A = 0.04812$ . So the the fitting curve of probability becomes as:

$$f(RSSI) = 0.04812 * e^{-(RSSI-53.44)^2/2\gamma^2} \quad (5.13)$$

# Chapter 6

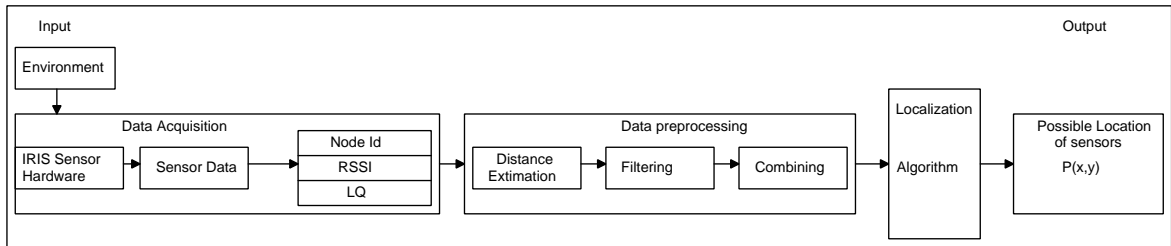
## RSS based Localization.

In chapter 6, Localization of sensor node is studied and based upon this study, RSS based localization is outlined. This chapter presents a detailed study of sensor selection for localization. Moreover RSS uncertainty, as investigated earlier helped to proceed for the localization. It helped to validate our experimental work for localization by incorporating 2.4 GHz Atmel ATmega1281 micro-controller. This model has taken into account of important constraints such as RSS influencing factors etc.

## 6.1 Introduction

Wireless sensor network technology incorporates the observation real world environmental events as well as objects which require minimal human intervention for collecting the required data and report to the BS. The variation in the number of sensor nodes to be used for this purpose is application dependent. For bigger application, it will be quite large in number.

For large scale deployment of the sensor node, it usually requires the geographical location information about where the event has happened. Accuracy in finding the location of the sensor node is challenging. By having the knowledge of location reduces the complexity of the algorithms in large scale Wireless sensor networks (Langendoen and Reijers, 2003). Here in this chapter RSS is used to localize the position of the sensor nodes with at least three reference sensor nodes.

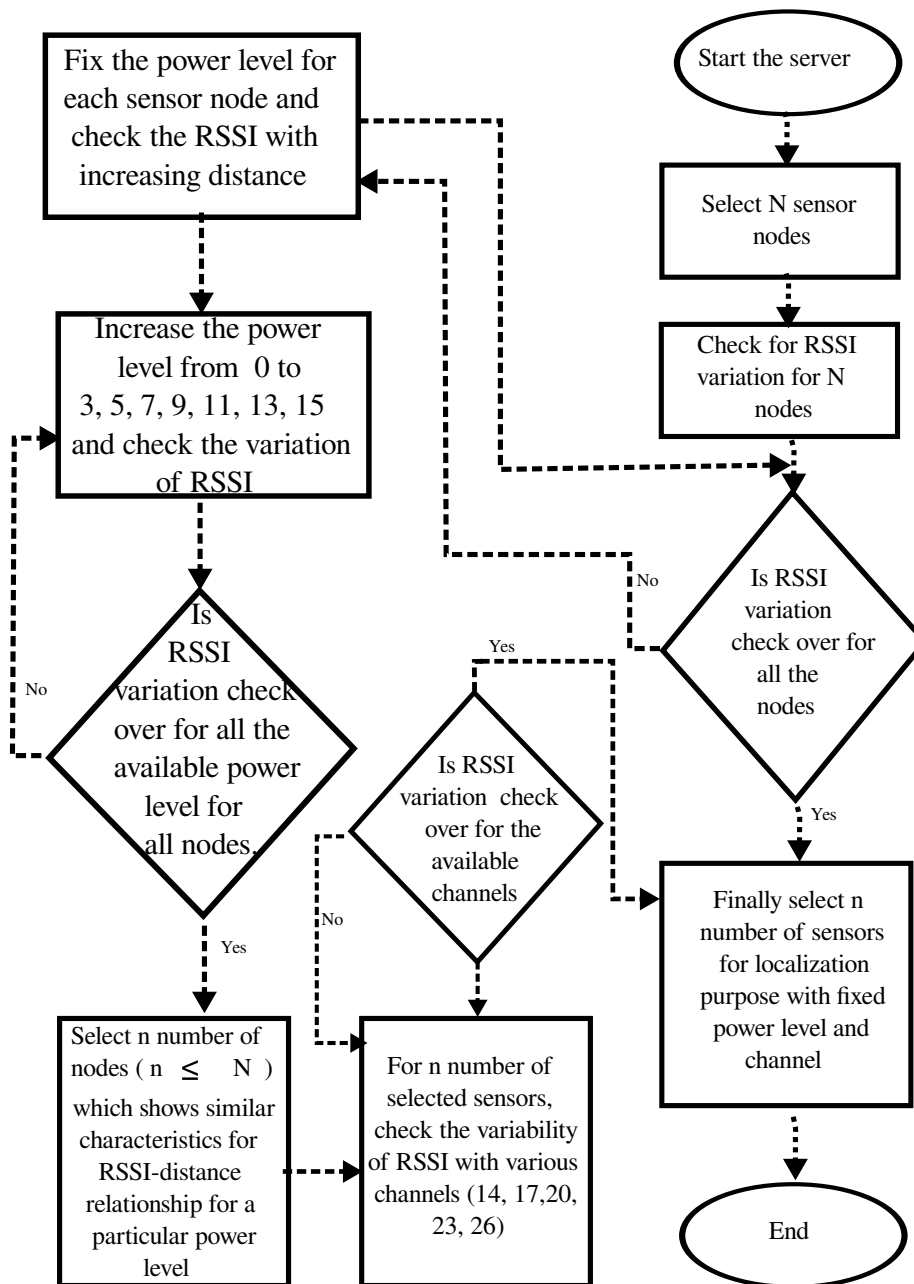


**Figure 6.1:** Procedure of Localization

Selection of sensor based on RSS variability was performed using the flow chart as given in Figure .6.2.

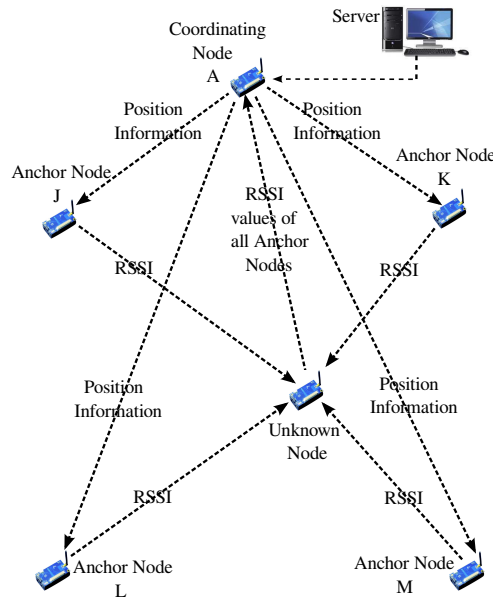
## 6.2 Experimental setup:

The experiment was conducted in the indoor (2D) region (research lab), with area of width  $2\text{m} \times$  length  $6\text{m}$ . It was divided into 65 points with origin point at the bottom left corner. Four red dots represent the position of the anchor nodes and blue dots represents the test points for the unknown node.



**Figure 6.2:** Flow chart to select the sensors for localization

Fig. 6.3 shows the architecture of the sensor network inside laboratory and Fig. 6.4 shows the real time placement of sensor nodes in lab environment. Placement of

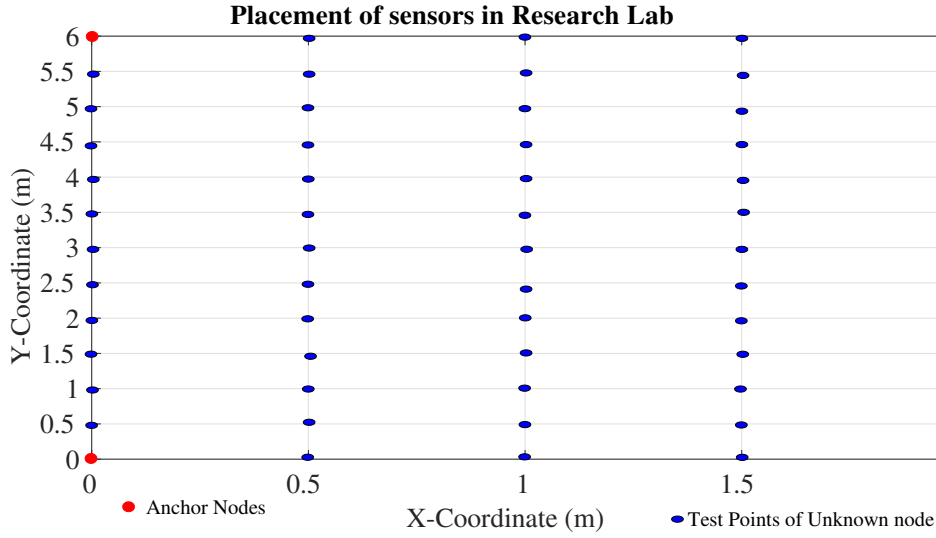


**Figure 6.3:** architecture for Distance estimation experiment



**Figure 6.4:** Real time placement of sensors for Location Estimation

four Anchor Nodes J, K, L, M with the coordinates  $(0,0)$ ,  $(0,6)$ ,  $(2,0)$ ,  $(2,6)$  and test points for the unknown node having the coordinates  $(x,y)$  which has to be determined, is shown in Fig. 6.5 .



**Figure 6.5:** Sensor placement for localization experiment

### 6.2.1 Flow Chart for Localization:

The approach to position estimation is given in the flow chart as shown in Fig. 6.6.

### 6.2.2 Algorithm for Localization:

The pseudocode for location estimation is presented in Algorithm 1.

The input to the algorithm comprise of  $k$  RSSI values at  $n$  different distances. At first we record 12 RSSI values at different time interval and then compute the mean and variance of all the 12 RSSI at each distance  $l_i$  { $i$  equals 1, 1.25, 1.5 ... 6m} (lines 3 to 10). To eliminate the abnormal values received at each distances, we need to compute  $[\mu - \sqrt{3}\gamma, \mu + \sqrt{3}\gamma]$ (Gaussian Filtering) (lines 11 and 12). To refine the received RSSI values, we use averaging filter (lines 14 to 18). Now distance is estimated by  $d_e(i)$  (lines 19 and 20). At last location is computed (line 21). Let  $RSSI_i$  be the received signal strength measured between the unknown node  $Q$  and the anchor nodes. Received RSSI were optimized using Gaussian and averaging filter.  $d_{e_i}$  is the estimated distance between the unknown node  $Q$  and the anchor nodes, which is calculated by a group of non-linear equations as:

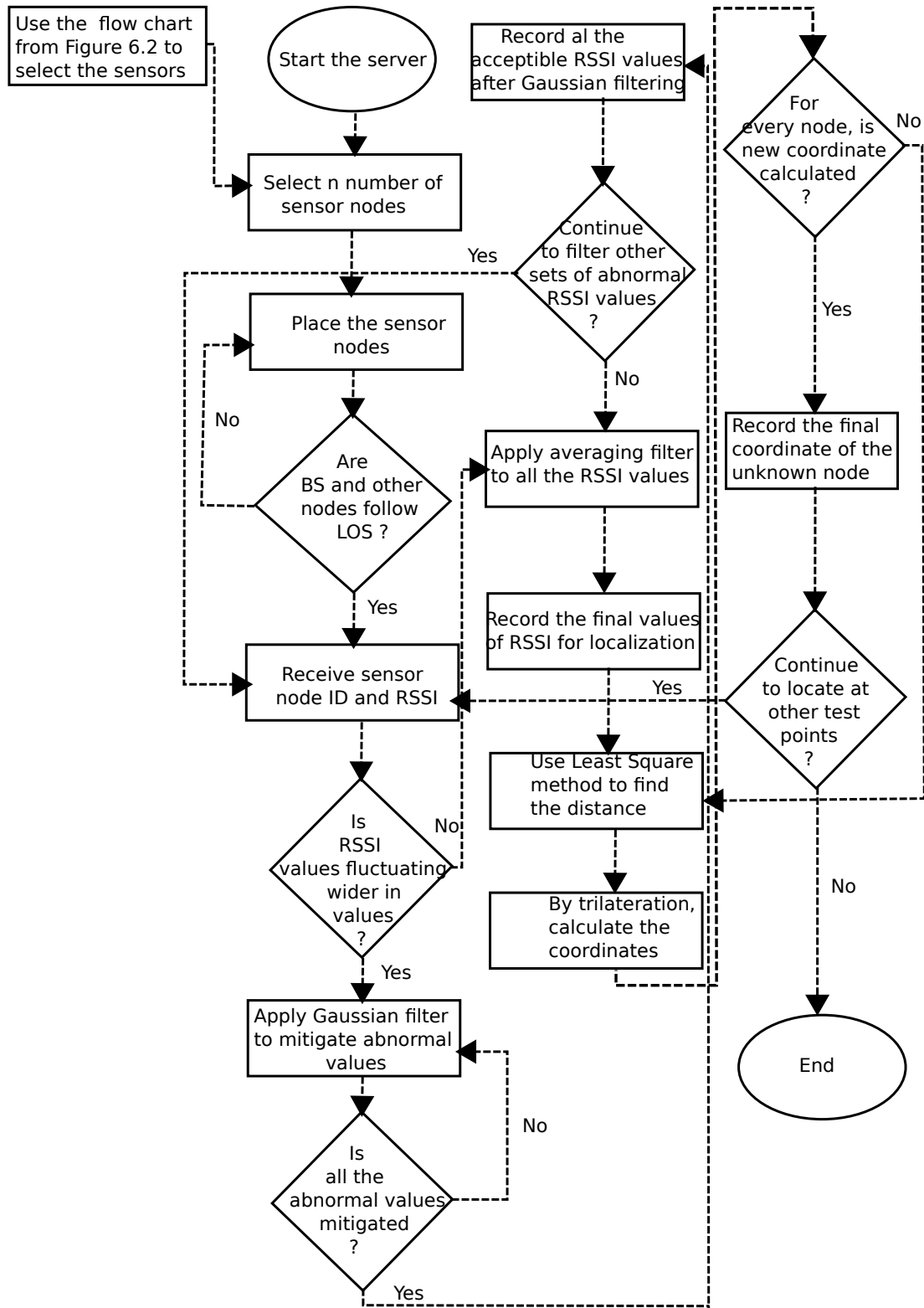


Figure 6.6: Flow chart for localization

---

**Algorithm 1** Location Estimation

---

- 1: INPUT:  $k$  no of RSSI samples at  $l$  no of distances.
- 2: OUTPUT: Estimated coordinates of test points.
- 3: Record all RSSI values.
- 4: **for**  $i = 1 : l$  **do**
- 5:     Initialize  $\mu(i) = 0$
- 6:     **for**  $j = 1 : k$  **do**
- 7:         Compute the mean  $\mu$ .

$$\mu(i) = \mu(i) + \frac{1}{k}RSSI(j)$$

- 8:     **end for**
- 9:     **for**  $j = 1 : k$  **do**
- 10:         Compute the variance  $\gamma$ .

$$\gamma^2(i) = \gamma^2(i) + \frac{1}{k-1}(RSSI(j) - \mu(i))^2$$

- 11:     **end for**
- 12:     Compute  $\mu(i) - \sqrt{3}\gamma(i)$ ,  $\mu(i) + \sqrt{3}\gamma(i)$
- 13:     Eliminate the RSSI values which are out of the range of  $[\mu(i) - \sqrt{3}\gamma(i), \mu(i) + \sqrt{3}\gamma(i)]$  and recompute mean  $\mu$  and variance  $\gamma$
- 14:     **end for**
- 15:     **for**  $i = 1 : l$  **do**
- 16:         Initialize  $RSSI_{avg}(i) = 0$
- 17:         **for**  $j = 1 : m$  **do**
- 18:             Compute RSSI by using averaging filter

$$RSSI_{avg}(i) = RSSI_{avg}(i) + \frac{1}{m}RSSI(j)$$

- 19:         **end for**
- 20:         Estimate the distance  $d_e(i)$  by LS

$$d_e(i) = 10 \frac{B + RSSI_{avg}(i)}{10n}$$

- 21:         **end for**
- 22:         Compute the estimated location

$$X = p^{-1}q$$

---



$$\begin{aligned}
(x_Q - x_J)^2 + (y_Q - y_J)^2 &= d_{e_1}^2 \\
(x_Q - x_K)^2 + (y_Q - y_K)^2 &= d_{e_2}^2 \\
(x_Q - x_L)^2 + (y_Q - y_L)^2 &= d_{e_3}^2 \\
(x_Q - x_M)^2 + (y_Q - y_M)^2 &= d_{e_4}^2
\end{aligned} \tag{6.1}$$

By subtracting fourth equation from first, second and third equation of equation (6.1), we get

$$\begin{aligned}
&x_J^2 - x_M^2 - 2(x_J - x_M)x_Q \\
&+ y_J^2 - y_M^2 - 2(y_J - y_M)y_Q = d_{e_1}^2 - d_{e_4}^2
\end{aligned} \tag{6.2}$$

$$\begin{aligned}
&x_K^2 - x_M^2 - 2(x_K - x_M)x_Q \\
&+ y_K^2 - y_M^2 - 2(y_K - y_M)y_Q = d_{e_2}^2 - d_{e_4}^2
\end{aligned} \tag{6.3}$$

$$\begin{aligned}
&x_L^2 - x_M^2 - 2(x_L - x_M)x_Q \\
&+ y_L^2 - y_M^2 - 2(y_L - y_M)y_Q = d_{e_3}^2 - d_{e_4}^2
\end{aligned} \tag{6.4}$$

Equation (6.2), equation (6.3), equation (6.4) can be shown as  $pX = q$ , where

$$p = \begin{pmatrix} 2(x_J - x_M) & 2(y_J - y_M) \\ 2(x_K - x_M) & 2(y_K - y_M) \\ 2(x_L - x_M) & 2(y_L - y_M) \end{pmatrix} \tag{6.5}$$

,

$$q = \begin{pmatrix} x_J^2 - x_M^2 + y_J^2 - y_M^2 - d_{e_1}^2 + d_{e_4}^2 \\ x_K^2 - x_M^2 + y_K^2 - y_M^2 - d_{e_2}^2 + d_{e_4}^2 \\ x_L^2 - x_M^2 + y_L^2 - y_M^2 - d_{e_3}^2 + d_{e_4}^2 \end{pmatrix} \tag{6.6}$$

and

$$X = \begin{pmatrix} x_Q \\ y_Q \end{pmatrix} \tag{6.7}$$

$$\begin{pmatrix} x_Q \\ y_Q \end{pmatrix} = \begin{pmatrix} 2(x_J - x_M) & 2(y_J - y_M) \\ 2(x_K - x_M) & 2(y_K - y_M) \\ 2(x_L - x_M) & 2(y_L - y_M) \end{pmatrix}^{-1} \cdot \begin{pmatrix} x_J^2 - x_M^2 + y_J^2 - y_M^2 - d_{e_1}^2 + d_{e_4}^2 \\ x_K^2 - x_M^2 + y_K^2 - y_M^2 - d_{e_2}^2 + d_{e_4}^2 \\ x_L^2 - x_M^2 + y_L^2 - y_M^2 - d_{e_3}^2 + d_{e_4}^2 \end{pmatrix} \quad (6.8)$$

In our experimental environment, signal propagation is affected by wall, building material even by movement of the human being. Hence it is difficult to estimate the parameter accurately in these environment. RSSI in general gets affected by multipath and shadowing which tends to the inaccuracy in the distance estimation which in turn affect the localization procedure. So, we have introduced noise in the distance estimation. Let the new noisy estimation be  $\tilde{d}$ , then equation (6.1) can be rewritten as:

$$\begin{aligned} (\tilde{x}_Q - x_J)^2 + (\tilde{y}_Q - y_J)^2 &= \tilde{d}_{e_1}^2 \\ (\tilde{x}_Q - x_K)^2 + (\tilde{y}_Q - y_K)^2 &= \tilde{d}_{e_2}^2 \\ (\tilde{x}_Q - x_L)^2 + (\tilde{y}_Q - y_L)^2 &= \tilde{d}_{e_3}^2 \\ (\tilde{x}_Q - x_M)^2 + (\tilde{y}_Q - y_M)^2 &= \tilde{d}_{e_4}^2 \end{aligned} \quad (6.9)$$

where  $(\tilde{x}, \tilde{y})$  is estimated coordinate of the unknown node Q. Hence the equation can be written as:

$$\begin{pmatrix} \tilde{x}_Q \\ \tilde{y}_Q \end{pmatrix} = \begin{pmatrix} 2(x_J - x_M) & 2(y_J - y_M) \\ 2(x_K - x_M) & 2(y_K - y_M) \\ 2(x_L - x_M) & 2(y_L - y_M) \end{pmatrix}^{-1} \cdot \begin{pmatrix} x_J^2 - x_M^2 + y_J^2 - y_M^2 - \tilde{d}_{e_1}^2 + \tilde{d}_{e_4}^2 \\ x_K^2 - x_M^2 + y_K^2 - y_M^2 - \tilde{d}_{e_2}^2 + \tilde{d}_{e_4}^2 \\ x_L^2 - x_M^2 + y_L^2 - y_M^2 - \tilde{d}_{e_3}^2 + \tilde{d}_{e_4}^2 \end{pmatrix} \quad (6.10)$$

By subtracting equation (6.10) from equation (6.8), we get the range error to be

$$\begin{pmatrix} \tilde{x}_Q - x_Q \\ \tilde{y}_Q - y_Q \end{pmatrix} = \begin{pmatrix} 2(x_J - x_M) & 2(y_J - y_M) \\ 2(x_K - x_M) & 2(y_K - y_M) \\ 2(x_L - x_M) & 2(y_L - y_M) \end{pmatrix}^{-1} \cdot \begin{pmatrix} (\tilde{d}_{e_1}^2 - d_{e_1}^2) - (\tilde{d}_{e_4}^2 - d_{e_4}^2) \\ (\tilde{d}_{e_2}^2 - d_{e_2}^2) - (\tilde{d}_{e_4}^2 - d_{e_4}^2) \\ (\tilde{d}_{e_3}^2 - d_{e_3}^2) - (\tilde{d}_{e_4}^2 - d_{e_4}^2) \end{pmatrix} \quad (6.11)$$

$$Z = \begin{pmatrix} (\tilde{d}_{e_1}^2 - d_{e_1}^2) - (\tilde{d}_{e_4}^2 - d_{e_4}^2) \\ (\tilde{d}_{e_2}^2 - d_{e_2}^2) - (\tilde{d}_{e_4}^2 - d_{e_4}^2) \\ (\tilde{d}_{e_3}^2 - d_{e_3}^2) - (\tilde{d}_{e_4}^2 - d_{e_4}^2) \end{pmatrix} \quad (6.12)$$

$$= \begin{pmatrix} (10^{(10+RSSI_1)/10n_1} - 10^{(10+RSSI_1)/10n_{PL_1}}) - (10^{(10+RSSI_4)/10n_4} - 10^{(10+RSSI_4)/10n_{PL_4}}) \\ (10^{(10+RSSI_2)/10n_2} - 10^{(10+RSSI_2)/10n_{PL_2}}) - (10^{(10+RSSI_4)/10n_4} - 10^{(10+RSSI_4)/10n_{PL_4}}) \\ (10^{(10+RSSI_3)/10n_3} - 10^{(10+RSSI_3)/10n_{PL_3}}) - (10^{(10+RSSI_4)/10n_4} - 10^{(10+RSSI_4)/10n_{PL_4}}) \end{pmatrix} \quad (6.13)$$

At each test point, we have estimated the coordinates several times. we have considered the average of all the coordinates as the final estimated coordinates. Let

$$x_{\tilde{Q}_j} = \frac{1}{m} \sum_{l=1}^m x_{Q_l} \quad \text{and} \quad y_{\tilde{Q}_j} = \frac{1}{m} \sum_{l=1}^m y_{Q_l} \quad (6.14)$$

where  $l \Rightarrow$  no. of times coordinates are estimated,  $m = 7$  for our experiment and  $j \Rightarrow$  different test point location. As  $(\tilde{x}_j, \tilde{y}_j)$  is estimated coordinate of the unknown node Q, hence, error based performance evaluation between real and estimated coordinates (Liu *et al.*, 2010), (Bachrach and Taylor, 2005), (He *et al.*, 2003), (Danielsson, 1980), (Patwari *et al.*, 2005) is given as :

$$E_{RSSI} = \frac{1}{k} \sum_{j=1}^k \sqrt{(x_{Q_j} - x_{\tilde{Q}_j})^2 + (y_{Q_j} - y_{\tilde{Q}_j})^2} \quad (6.15)$$

## 6.3 Localization Application:

### 6.3.1 Need for Localization:

- Police officers as well as people involved in firefighting lose their precious lives during the dangerous situations or patients and old people who face some dangerous moments in critical conditions need on time and fast help. Hence by the use of wireless sensor networks by collecting and providing the critical data from the victims to the server by controlling immediately and helping them at that instant, would be useful. To achieve this, we need to locate the position first and then observe their critical conditions to act upon.
- In big supermarkets, it is possible to route people to find their needs in a flexible

manner to save their time for searching for it by finding the location of the object.

- In hospitals, finding the location of patient or doctor will be helpful to provide service in time for any critical conditions.

To have all those services efficiently, people or machines need to be equipped with sensors.

### **6.3.2 Need for accuracy:**

Localization in real field application has become the most critical and vital aspect to look upon in the field of communication. Several architectures, techniques, algorithms and protocols have been introduced by no of researchers as well by engineers to achieve accuracy in localization. But to reach a better accuracy level, there is a need for repetitive experiments based on different scenarios. Accuracy degrades in most of the cases where it is undefinable such as because of humidity, peoples, light intensity etc.

Some of the critical notes have to be considered for accuracy in localization such as:

- Locating the position of anchor nodes, persons or any objects.
- Supervising the health condition of the people (health sensors).
- Battery level of the sensors.

# Chapter 7

## Conclusion and Future directions.

In this paper, we have experimented on RSSI based location technique in wireless sensor network. To get the optimum RSSI values, we have conducted several experiments which carried large amount of experimented data. We have also estimated the related RSSI influencing parameters and have efficiently used Gaussian filtering for optimizing the RSSI values. Analysis of RSSI variation due to power, frequency as well as movement of receiver was done extensively. The proposed position estimation algorithm combined the use of sensor selection process as well as the Gaussian filtering and average filtering with the implementation of trilateration, which helped to estimate the position of the unknown nodes.

In accordance with the results obtained in our research, we contemplate to conduct the studies on these following issues in future.

- When anchor nodes are replaced, the mean and variance values of the RSS changed significantly. The experiments can be performed with more number of samples as well as with the presence of more number of obstacles in various environmental conditions and analyze the new results.
- As shadowing effect possess large influence on location accuracy, To improve the accuracy, more experiments need to be performed.
- Number of anchor nodes play an important role in accuracy, we intend to increase the number of anchor nodes in our future work.
- In future, we intend to extend the proposed approach to comply with other several localization approach such as global positioning system, Wireless Fidelity.

# Bibliography

- Adewumi, O. G., Djouani, K. and Kurien, A. M. (2013). Rssi based indoor and outdoor distance estimation for localization in wsn, *Industrial Technology (ICIT), 2013 IEEE International Conference on*, IEEE, pp. 1534–1539.
- Akyildiz, I. F., Su, W., Sankarasubramaniam, Y. and Cayirci, E. (2002). A survey on sensor networks, *Communications magazine, IEEE* **40**(8): 102–114.
- Awang, A. and Agarwal, S. (2013). Data aggregation using rssi for multihop wireless sensor networks, *Wireless Communications & Signal Processing (WCSP), 2013 International Conference on*, IEEE, pp. 1–6.
- Bachrach, J. and Taylor, C. (2005). Localization in sensor networks, *Handbook of sensor networks: Algorithms and Architectures* **1**.
- Bahl, P. and Padmanabhan, V. N. (2000). Radar: An in-building rf-based user location and tracking system, *INFOCOM 2000. Nineteenth Annual Joint Conference of the IEEE Computer and Communications Societies. Proceedings. IEEE*, Vol. 2, Ieee, pp. 775–784.
- Barralet, M., Huang, X. and Sharma, D. (2009). Effects of antenna polarization on rssi based location identification, *Advanced Communication Technology, 2009. ICACT 2009. 11th International Conference on*, Vol. 1, IEEE, pp. 260–265.
- Barsocchi, P., Lenzi, S., Chessa, S. and Giunta, G. (2009). A novel approach to indoor rssi localization by automatic calibration of the wireless propagation model, *Vehicular Technology Conference, 2009. VTC Spring 2009. IEEE 69th*, IEEE, pp. 1–5.
- Bergamo, P. and Mazzini, G. (2002). Localization in sensor networks with fading

- and mobility, *Personal, Indoor and Mobile Radio Communications, 2002. The 13th IEEE International Symposium on*, Vol. 2, IEEE, pp. 750–754.
- Blake, R. (2000). *Wireless communication technology*, Delmar Thomson Learning.
- Boukerche, A. (2008). *Algorithms and protocols for wireless sensor networks*, Vol. 62, John Wiley & Sons.
- Boukerche, A., Oliveira, H. A., Nakamura, E. F. and Loureiro, A. A. (2007). Localization systems for wireless sensor networks, *IEEE wireless Communications* **14**(6).
- Buchman, A. and Lung, C. (2013). Received signal strength based room level accuracy indoor localisation method, *Cognitive Infocommunications (CogInfoCom), 2013 IEEE 4th International Conference on*, IEEE, pp. 103–108.
- Caffery, J. J. (2000). *Wireless location in CDMA cellular radio systems*, Springer.
- Caruso, M. J. and Withanawasam, L. S. (1999). Vehicle detection and compass applications using amr magnetic sensors, *Sensors Expo Proceedings*, Vol. 477, p. 39.
- Chen, J. C., Yao, K. and Hudson, R. E. (2002). Source localization and beamforming, *Signal Processing Magazine, IEEE* **19**(2): 30–39.
- Chen, J., Wu, X.-j., Ye, F., Song, P. and Liu, J.-w. (2009). Improved rssi-based localization algorithm for park lighting control and child location tracking, *Information and Automation, 2009. ICIA'09. International Conference on*, IEEE, pp. 1526–1531.
- Chen, Z., Jiang, Y., He, R. and Yin, F. (2015). A novel rssi-based wireless localization algorithm, *Systems and Computer Technology: Proceedings of the 2014 International Symposium on Systmes and Computer technology, (ISSCT 2014), Shanghai, China, 15-17 November 2014*, CRC Press, p. 91.
- Chuku, N., Pal, A. and Nasipuri, A. (2013). An rssi based localization scheme for wireless sensor networks to mitigate shadowing effects, *Proceedings of the IEEE SoutheastCon*, pp. 1–6.

- Dalce, R., Van den Bossche, A. and Val, T. (2012). Towards a new range-based localization method for wsns: Challenges, constraints and correction, *Wireless Communications in Unusual and Confined Areas (ICWCUCA), 2012 International Conference on*, IEEE, pp. 1–6.
- Danielsson, P.-E. (1980). Euclidean distance mapping, *Computer Graphics and image processing* **14**(3): 227–248.
- Dargie, W. and Poellabauer, C. (2010). *Fundamentals of wireless sensor networks: theory and practice*, John Wiley & Sons.
- Dieng, N. A., Charbit, M., Chaudet, C., Toutain, L. and ben Meriem, T. (2013). Indoor localization in wireless networks based on a two-modes gaussian mixture model, *Vehicular Technology Conference (VTC Fall), 2013 IEEE 78th*, IEEE, pp. 1–5.
- Durgin, G. D. (2003). *Space-time wireless channels*, Prentice Hall Professional.
- El Assaf, A., Zaidi, S., Affes, S. and Kandil, N. (2015). Accurate nodes localization in anisotropic wireless sensor networks, *International Journal of Distributed Sensor Networks* .
- El Assaf, A., Zaidi, S., Affes, S. and Kandil, N. (n.d.). Accurate nodes localization in anisotropic wireless sensor networks.
- Elangovan, V. (2008). *Development of software system for localization of stationary wireless sensor nodes*, ProQuest.
- Elnahrawy, E., Austen-Francisco, J. and Martin, R. P. (2007). Adding angle of arrival modality to basic rss location management techniques, *Wireless Pervasive Computing, 2007. ISWPC'07. 2nd International Symposium on*, IEEE.
- Elnahrawy, E., Li, X. and Martin, R. P. (2004). The limits of localization using signal strength: A comparative study, *Sensor and Ad Hoc Communications and Networks, 2004. IEEE SECON 2004. 2004 First Annual IEEE Communications Society Conference on*, IEEE, pp. 406–414.
- Feng, C., Au, W. S. A., Valaee, S. and Tan, Z. (2012). Received-signal-strength-based indoor positioning using compressive sensing, *IEEE Transactions on Mobile Computing* **11**(12): 1983–1993.



- Foong, E., Wang, C. and Xiao, L. (2006). A study of radio signal behaviors in complex environments.
- Gai, M. and Azadmanesh, A. (2014). Sensor localization for indoor wireless sensor networks, *Performance Evaluation of Computer and Telecommunication Systems (SPECTS 2014), International Symposium on*, IEEE, pp. 536–541.
- Gezici, S. (2008). A survey on wireless position estimation, *Wireless Personal Communications* **44**(3): 263–282.
- Goldsmith, A. (2005). *Wireless communications*, Cambridge university press.
- Guo, Z., Guo, Y., Hong, F., Jin, Z., He, Y., Feng, Y. and Liu, Y. (2010). Perpendicular intersection: locating wireless sensors with mobile beacon, *Vehicular Technology, IEEE Transactions on* **59**(7): 3501–3509.
- Guvenc, I. and Chong, C.-C. (2009). A survey on toa based wireless localization and nlos mitigation techniques, *Communications Surveys & Tutorials, IEEE* **11**(3): 107–124.
- Hamdoun, S., Rachedi, A. and Benslimane, A. (2013). Comparative analysis of rssi-based indoor localization when using multiple antennas in wireless sensor networks, *Mobile and Wireless Networking (MoWNeT), 2013 International Conference on Selected Topics in*, IEEE, pp. 146–151.
- Hashemi, H. (1993). The indoor radio propagation channel, *Proceedings of the IEEE* **81**(7): 943–968.
- He, T., Huang, C., Blum, B. M., Stankovic, J. A. and Abdelzaher, T. (2003). Range-free localization schemes for large scale sensor networks, *Proceedings of the 9th annual international conference on Mobile computing and networking*, ACM, pp. 81–95.
- Heurtefeux, K. and Valois, F. (2012). Is rssi a good choice for localization in wireless sensor network?, *Advanced Information Networking and Applications (AINA), 2012 IEEE 26th International Conference on*, IEEE, pp. 732–739.
- Hightower, J., Want, R. and Borriello, G. (2000). Spoton: An indoor 3d location sensing technology based on rf signal strength.

- Holtzman, J. M. (1992). A simple, accurate method to calculate spread-spectrum multiple-access error probabilities, *IEEE Transactions on Communications* **40**(3): 461–464.
- Holtzmann, J. (1992). On using perturbation analysis to do sensitivity analysis: derivatives versus differences, *IEEE transactions on automatic control* **37**(2): 243–247.
- Huang, Y., Zheng, J., Xiao, Y. and Peng, M. (2015). Robust localization algorithm based on the rssi ranging scope, *International Journal of Distributed Sensor Networks* **2015**.
- Ilyas, M. and Mahgoub, I. (2006). *Smart Dust: Sensor network applications, architecture and design*, CRC press.
- Kloos, G., Guivant, J. E., Nebot, E. M. and Masson, F. (2006). Range based localisation using rf and the application to mining safety, *Intelligent Robots and Systems, 2006 IEEE/RSJ International Conference on*, IEEE, pp. 1304–1311.
- Knaian, A. N. (2000). *A wireless sensor network for smart roadbeds and intelligent transportation systems*, PhD thesis, Massachusetts Institute of Technology.
- Koh, B. and Dyke, S. (2007). Structural health monitoring for flexible bridge structures using correlation and sensitivity of modal data, *Computers & structures* **85**(3): 117–130.
- Koks, D. (2007). Numerical calculations for passive geolocation scenarios, *Technical report*, DTIC Document.
- Krishnamachari, B. (2005). *Networking wireless sensors*, Cambridge University Press.
- Kucuk, K., Kavak, A., Yigit, H. and Ozdemir, C. (2008). A novel localization technique for wireless sensor networks using adaptive antenna arrays, *Radio and Wireless Symposium, 2008 IEEE*, IEEE, pp. 483–486.
- Kumagai, J. and Cherry, S. (2004). Sensors and sensibility, *IEEE Spectrum* **41**(7): 22–26.

- Kuo, S.-P., Tseng, Y.-C., Wu, F.-J. and Lin, C.-Y. (2005). A probabilistic signal-strength-based evaluation methodology for sensor network deployment, *International Journal of Ad Hoc and Ubiquitous Computing* **1**(1-2): 3–12.
- Laitinen, H., Juurakko, S., Lahti, T., Korhonen, R. and Lahteenmaki, J. (2007). Experimental evaluation of location methods based on signal-strength measurements, *IEEE transactions on vehicular technology* **56**(1): 287–296.
- Langendoen, K. and Reijers, N. (2003). Distributed localization in wireless sensor networks: a quantitative comparison, *Computer Networks* **43**(4): 499–518.
- Lazos, L. and Poovendran, R. (2005). Serloc: Robust localization for wireless sensor networks, *ACM Transactions on Sensor Networks (TOSN)* **1**(1): 73–100.
- Lee, J. G., Kim, J., Lee, S. W. and Ko, Y. W. (2017). A location tracking system using ble beacon exploiting a double-gaussian filter., *KSI Transactions on Internet & Information Systems* **11**(2).
- Lee, J.-Y. and Scholtz, R. A. (2002). Ranging in a dense multipath environment using an uwb radio link, *IEEE Journal on Selected Areas in Communications* **20**(9): 1677–1683.
- Li, D., Wong, K. D., Hu, Y. H. and Sayeed, A. M. (2002). Detection, classification, and tracking of targets, *Signal Processing Magazine, IEEE* **19**(2): 17–29.
- Li, X. (2006). Rss-based location estimation with unknown pathloss model, *IEEE Transactions on Wireless Communications* **5**(12).
- Li, X. (2013). Signal strength differentiation based navigation of mobile robot in wireless sensor networks, *Industrial Electronics and Applications (ICIEA), 2013 8th IEEE Conference on*, IEEE, pp. 1908–1913.
- Lin, L., So, H.-C., Chan, F. K., Chan, Y. T. and Ho, K. (2013). A new constrained weighted least squares algorithm for tdoa-based localization, *Signal Processing* **93**(11): 2872–2878.
- Liu, B.-C., Lin, K.-H. and Wu, J.-C. (2006). Analysis of hyperbolic and circular positioning algorithms using stationary signal-strength-difference measurements in wireless communications, *Vehicular Technology, IEEE Transactions on* **55**(2): 499–509.

- Liu, L., Zhang, H., Geng, X. and Shu, X. (2013). Hexahedral localization (hl): A three-dimensional hexahedron localization based on mobile beacons, *The Scientific World Journal* **2013**.
- Liu, Y., Yang, Z., Wang, X. and Jian, L. (2010). Location, localization, and localizability, *Journal of computer science and technology* **25**(2): 274–297.
- Livinsa, Z. M. and Jayashri, S. (2013). Performance analysis of diverse environment based on rssi localization algorithms in wsns, *Information & Communication Technologies (ICT), 2013 IEEE Conference on*, IEEE, pp. 572–576.
- Luo, Q., Peng, Y., Li, J. and Peng, X. (2016). Rssi-based localization through uncertain data mapping for wireless sensor networks, *IEEE Sensors Journal* **16**(9): 3155–3162.
- Mao, G., Fidan, B. and Anderson, B. D. (2007). Wireless sensor network localization techniques, *Computer networks* **51**(10): 2529–2553.
- MEMSIC (2012). Memsic:powerful sensing solutions, <http://www.memsic.com/support/technical-documentation.cfm>.
- Moravek, P., Komosny, D., Simek, M., Jelinek, M., Girbau, D. and Lazaro, A. (2013). Investigation of radio channel uncertainty in distance estimation in wireless sensor networks, *Telecommunication systems* **52**(3): 1549–1558.
- Mukhopadhyay, B., Sarangi, S. and Kar, S. (2014). Novel rssi evaluation models for accurate indoor localization with sensor networks, *Communications (NCC), 2014 Twentieth National Conference on*, IEEE, pp. 1–6.
- Niculescu, D. and Nath, B. (2003a). Ad hoc positioning system (aps) using aoa, *INFOCOM 2003. Twenty-Second Annual Joint Conference of the IEEE Computer and Communications. IEEE Societies*, Vol. 3, IEEE, pp. 1734–1743.
- Niculescu, D. and Nath, B. (2003b). Localized positioning in ad hoc networks, *Ad Hoc Networks* **1**(2): 247–259.
- Papamantou, C., Preparata, F. P. and Tamassia, R. (2008). Algorithms for location estimation based on rssi sampling, *Algorithmic Aspects of Wireless Sensor Networks*, Springer, pp. 72–86.

- Parodi, B. B., Lenz, H., Szabo, A., Wang, H., Horn, J., Bamberger, J. and Obradovic, D. (2006). Initialization and online-learning of rss maps for indoor/campus localization, *Position, Location, And Navigation Symposium, 2006 IEEE/ION*, IEEE, pp. 164–172.
- Patwari, N., Ash, J. N., Kyperountas, S., Hero, A. O., Moses, R. L. and Correal, N. S. (2005). Locating the nodes: cooperative localization in wireless sensor networks, *IEEE Signal processing magazine* **22**(4): 54–69.
- Patwari, N., Hero, A. O., Perkins, M., Correal, N. S. and O’dea, R. J. (2003). Relative location estimation in wireless sensor networks, *Signal Processing, IEEE Transactions on* **51**(8): 2137–2148.
- Patwari, N. and Hero III, A. O. (2003). Using proximity and quantized rss for sensor localization in wireless networks, *Proceedings of the 2nd ACM international conference on Wireless sensor networks and applications*, ACM, pp. 20–29.
- Peng, R. and Sichitiu, M. L. (2006). Angle of arrival localization for wireless sensor networks, *Sensor and Ad Hoc Communications and Networks, 2006. SECON’06. 2006 3rd Annual IEEE Communications Society on*, Vol. 1, IEEE, pp. 374–382.
- Qu, H. and Wicker, S. B. (2006). Anchor-free localization in rapidly-deployed wireless sensor networks, *Mobile Adhoc and Sensor Systems (MASS), 2006 IEEE International Conference on*, IEEE, pp. 627–632.
- Rappaport, T. S., Reed, J. and Woerner, B. D. (1996). Position location using wireless communications on highways of the future, *Communications Magazine, IEEE* **34**(10): 33–41.
- Rappaport, T. S. et al. (1996). *Wireless communications: principles and practice*, Vol. 2, Prentice Hall PTR New Jersey.
- Razul, S. G., Lim, C.-H. and See, C.-M. S. (2011). Bayesian method for nlos mitigation in single moving sensor geo-location, *Signal Processing* **91**(7): 1613–1621.
- Römer, K. (2003). The lighthouse location system for smart dust, *Proceedings of the 1st international conference on Mobile systems, applications and services*, ACM, pp. 15–30.

- Sahinoglu, Z. and Gezici, S. (2006). Ranging in the iee 802.15. 4a standard, *Wireless and Microwave Technology Conference, 2006. WAMICON'06. IEEE Annual*, IEEE, pp. 1–5.
- Sahu, O. and Dubey, T. (2009). A new approach for self localization of wireless sensor network, *Indian Journal of Science and Technology* **2**(11): 1–4.
- Santi, P. (2005). Topology control in wireless ad hoc and sensor networks, *ACM computing surveys (CSUR)* **37**(2): 164–194.
- Savvides, A., Han, C.-C. and Strivastava, M. B. (2001). Dynamic fine-grained localization in ad-hoc networks of sensors, *Proceedings of the 7th annual international conference on Mobile computing and networking*, ACM, pp. 166–179.
- Si-qi, B., Wen-hai, L. and Shuang, Q. (2014). Accurate path-loss exponent correcting location method, *Control Conference (CCC), 2014 33rd Chinese*, IEEE, pp. 472–475.
- Sichitiu, M. L. and Ramadurai, V. (2004). Localization of wireless sensor networks with a mobile beacon, *Mobile Ad-hoc and Sensor Systems, 2004 IEEE International Conference on*, IEEE, pp. 174–183.
- Stojmenovic, I. (2005). *Handbook of sensor networks: Algorithms and architectures*, Vol. 49, John Wiley & Sons.
- Stoleru, R. and Stankovic, J. A. (2004). Probability grid: A location estimation scheme for wireless sensor networks, *Sensor and Ad Hoc Communications and Networks, 2004. IEEE SECON 2004. 2004 First Annual IEEE Communications Society Conference on*, IEEE, pp. 430–438.
- Sugano, M., Kawazoe, T., Ohta, Y. and Murata, M. (2006). Indoor localization system using rssi measurement of wireless sensor network based on zigbee standard, *Target* **538**: 050.
- Sun, Z., Qie, X., Liu, M., Cao, D. and Wang, D. (2013). Lightning vhf radiation location system based on short-baseline tdoa techniquevalidation in rocket-triggered lightning, *Atmospheric Research* **129**: 58–66.

- Tian, S., Zhang, X., Liu, P., Sun, P. and Wang, X. (2007). A rssi-based dv-hop algorithm for wireless sensor networks, *Wireless Communications, Networking and Mobile Computing, 2007. WiCom 2007. International Conference on*, IEEE, pp. 2555–2558.
- TURINT, G. L. (1960). An introduction to matched filters.
- Vadivukkarasi, K. and Kumar, R. (2013). A new approach for error reduction in localization for wireless sensor networks, *Int. J. on Recent Trends in Engineering and Technology* **8**(2).
- Vander Stoep, J. (2009). *Design and implementation of reliable localization algorithms using received signal strength*, PhD thesis, University of Washington.
- Visser, H. J. (2006). *Array and phased array antenna basics*, John Wiley & Sons.
- Whitehouse, K., Karlof, C. and Culler, D. (2007). A practical evaluation of radio signal strength for ranging-based localization, *ACM SIGMOBILE Mobile Computing and Communications Review* **11**(1): 41–52.
- Xiao, L., Yin, Y., Wu, X. and Wang, J. (2013). A large-scale rf-based indoor localization system using low-complexity gaussian filter and improved bayesian inference, *Radioengineering* **22**(1).
- Xu, J., Liu, W., Lang, F., Zhang, Y., Wang, C. et al. (2010). Distance measurement model based on rssi in wsn., *Wireless Sensor Network* **2**(8): 606–611.
- Yedavalli, K., Krishnamachari, B., Ravula, S. et al. (2005). Ecolocation: A technique for rf based localization in wireless sensor networks [c], *Proceedings of Information Processing in Sensor Networks (IPSN), Los Angeles, CA* .
- Zanca, G., Zorzi, F., Zanella, A. and Zorzi, M. (2008). Experimental comparison of rssi-based localization algorithms for indoor wireless sensor networks, *Proceedings of the workshop on Real-world wireless sensor networks*, ACM, pp. 1–5.

# Publications based on the thesis

## *Refereed International Journals/Conferences*

### Journal Publications

1. Mahapatra, Ranjan Kumar, and Shet. N.S.V. "Localization based on RSSI Exploiting Gaussian and Average Filter in Wireless Sensor Network" *AJSE, Springer*. **SCI Indexed**  
<https://doi.org/10.1007/s13369-017-2826-2>.
2. Mahapatra, Ranjan Kumar, and Shet. N.S.V. "Experimental analysis of factors influencing RSSI for localization in wireless sensor network" *Radio Engineering*. **SCI Indexed**  
Communicated, Under review.

### Conferences Publications

1. Mahapatra, Ranjan Kumar, and Shet. N.S.V. "Experimental Analysis of RSSI-based Distance Estimation for Wireless Sensor Networks" *DISCOVER*, IEEE, 2016. DOI: **10.1109/DISCOVER.2016.7806221**
2. Mahapatra, Ranjan Kumar, and Shet. N.S.V. "Topology Control in Wireless Sensor Networks : A Survey" *ICIECE* , 2017, Accepted for Publication.



## Bio-data

### *Personal Details:*

Name : Ranjan Kumar Mahapatra  
Address : S/o: Baikunthanath Mahapatra.  
Plot No: 311, K-3-B, Kalinga Nagar.  
Ghatikia, At/Po: Ghatikia  
Bhubaneswar, Dist: Khurda,  
Odisha, 751003  
Contact Number: +91 8277522175  
+91 9178252175.  
Email ID : mahapatra.ranjankumar@gmail.com

### *Educational Qualification:*

Degree	Name of the Institute	Year of passing	Division
MTech (Communication System Engineering)	Kalinga Institute of Industrial Technology	2010	1 <sup>st</sup>
BE (Electronics and Communication Engineering)	C.V.Raman College of Engineering	2002	1 <sup>st</sup>